



INSTRUCTION MANUAL

VHF MARINE TRANSCEIVER IC-M601



Icom Inc.

FOREWORD

Thank you for purchasing this Icom product. The IC-M601 VHF MARINE TRANSCEIVER is designed and built with Icom's state of the art technology and craftsmanship. With proper care, this product should provide you with years of trouble-free operation.

We want to take a couple of moments of your time to thank you for making the IC-M601 your radio of choice, and hope you agree with Icom's philosophy of "technology first." Many hours of research and development went into the design of your IC-M601.

◇ **FEATURES**

○ *Built-in DSC meets ITU Class D requirement*

An independent receiver continuously watches Ch. 70, while using another channel. Further, a single antenna connector allows VHF and Ch. 70 operation, thus simplifying installation. The 10-key pad allows simple and efficient operation of the DSC emergency functions, vital for your safety at sea.

○ *Superior receiver performance*

The IC-M601 has excellent receive specifications of more than 75 dB for spurious response, and intermodulation

rejection. With such high level performance, received calls are remarkably clear and free from noise. The powerful audio output from the front facing speaker further increases the clarity of received calls.

○ *Optional COMMANDMIC (2 systems are connectable)*

The optional COMMANDMIC provides a 2nd and 3rd station capability and an intercom function. With slim dimension and sizable LCD, the COMMANDMIC offers ease and convenience of operating the radio from remote locations such as the cockpit or tower up to a max. 21 m* from the IC-M601.

* Requires use of optional OPC-999 extension cables.

○ *Large LCD with dot matrix characters*

The large dot-matrix display is designed for optimum readability in any lighting condition. With the extra large font, the channel number is maximized on the display and other information can be easily read.

○ *Rugged waterproof construction*

The IC-M601 including the supplied (HM-137)/optional (HM-134) microphone has effective waterproofing equivalent to JIS waterproof grade 7*.

* 1 m/30 min; except cables.

IMPORTANT

READ THIS INSTRUCTION MANUAL CAREFULLY before attempting to operate the transceiver.

SAVE THIS INSTRUCTION MANUAL. This manual contains important safety and operating instructions for the IC-M601.

CLEAN THE TRANSCEIVER AND MICROPHONE THOROUGHLY WITH FRESH WATER after exposure to water including salt water, otherwise, the keys and switches may become inoperable due to salt crystallization.

Icom, Icom Inc. and the  logo are registered trademarks of Icom Incorporated (Japan) in the United States, the United Kingdom, Germany, France, Spain, Russia and/or other countries.

EXPLICIT DEFINITIONS

WORD	DEFINITION
 WARNING	Personal injury, fire hazard or electric shock may occur.
CAUTION	Equipment damage may occur.
NOTE	If disregarded, inconvenience only. No risk or personal injury, fire or electric shock.

 Versions of the IC-M601 which display the “CE” symbol on the serial number seal, comply with the essential requirements of the European Radio and Telecommunication Terminal Directive 1999/5/EC.

 This warning symbol indicates that this equipment operates in non-harmonised frequency bands and/or may be subject to licensing conditions in the country of use. Be sure to check that you have the correct version of this radio or the correct programming of this radio, to comply with national licensing requirements.

IN CASE OF EMERGENCY

If your vessel requires assistance, contact other vessels and the Coast Guard by sending a distress call on Channel 16.

USING CHANNEL 16

DISTRESS CALL PROCEDURE

1. "MAYDAY MAYDAY MAYDAY."
2. "THIS IS" (name of vessel)
3. Your call sign or other indication of the vessel (AND 9-digit DSC ID if you have one).
4. "LOCATED AT" (your position)
5. The nature of the distress and assistance required.
6. Any other information which might facilitate the rescue.

Or, transmit your distress call using digital selective calling on Channel 70.

USING DIGITAL SELECTIVE CALLING (Ch 70)

DISTRESS CALL PROCEDURE

1. While lifting up the switch cover, push and hold [DISTRESS] for 5 sec. until you hear 5 short beeps change to one long beep.
2. Wait for an acknowledgment from a coast station.
 - Channel 16 is automatically selected.
3. Push and hold [PTT], then transmit the appropriate information as at left.

TABLE OF CONTENTS

FOREWORD	i	■ Position indication	17	12 SPECIFICATIONS AND	
IMPORTANT	ii	■ Distress call	18	OPTIONS	47
EXPLICIT DEFINITIONS	ii	■ Transmitting DSC calls	19	■ Specifications	47
IN CASE OF EMERGENCY	iii	■ Setting the distress information ...	23	■ Options	47
TABLE OF CONTENTS	iv	■ DSC individual ID	24	13 HM-134 REMOTE-CONTROL	
PRECAUTION	v	■ Receiving DSC calls	27	MICROPHONE	48–58
1 OPERATING RULES	1	■ DSC set mode	29	■ Panel description	48
2 PANEL DESCRIPTION	2–7	■ Received messages	31	■ Function display	50
■ Panel description	2	7 OTHER FUNCTIONS	33–36	■ Channel selection	52
■ Function display	6	■ Hailer operation	33	■ Receiving and transmitting	53
■ Microphone (HM-137).....	7	■ Automatic foghorn	34	■ Lock functions	54
3 BASIC OPERATION	8–12	■ Microphone lock function	35	■ Display backlighting	54
■ Channel selection	8	■ Intercom operation	36	■ Monitor function	54
■ Receiving and transmitting	10	8 SET MODE	37–39	■ Call channel programming	55
■ Call channel programming	11	■ Set mode programming	37	■ Starting a scan	55
■ Channel comments	11	■ Set mode items	38	■ Setting tag channels	56
4 DUALWATCH/TRI-WATCH	13	9 CONNECTIONS AND		■ Dualwatch/Tri-watch operation	56
■ Description	13	MAINTENANCE	40–44	■ Set mode programming	57
■ Operation	13	■ Supplied accessories	40	■ Intercom operation	58
5 SCAN OPERATIONS	14–15	■ Antenna	40	■ Channel comments	58
■ Scan types	14	■ Fuse replacement	40	14 HM-134 CONNECTIONS AND	
■ Setting tag channels	15	■ Cleaning	40	INSTALLATION	59–60
■ Starting a scan	15	■ Connections	41	■ HM-134 supplied accessories	59
6 DSC OPERATION	16–32	■ Mounting the transceiver	42	■ Installation	59
■ MMSI code programming	16	■ Dimensions.....	44	INSTALLATION NOTES	
■ Position and time programming	16	10 TROUBLESHOOTING	45	HM-134 TEMPLATE	
		11 CHANNEL LIST	46		

1
2
3
4
5
6
7
8
9
10
11
12
13
14

PRECAUTION

⚠ **WARNING! NEVER** connect the transceiver to an AC outlet. This may pose a fire hazard or result in an electric shock.

NEVER connect the transceiver to a power source of more than 16 V DC or use reverse polarity. This will ruin the transceiver.

NEVER cut the DC power cable between the DC plug and fuse holder. If an incorrect connection is made after cutting, the transceiver may be damaged.

NEVER place the transceiver where normal operation of the vessel may be hindered or where it could cause bodily injury.

KEEP the transceiver at least 1 m away from the ship's navigation compass.

DO NOT use or place the transceiver in areas with temperatures below -20°C or above $+60^{\circ}\text{C}$ or in areas subject to direct sunlight, such as the dashboard.

AVOID the use of chemical agents such as benzine or alcohol when cleaning, as they may damage the transceiver surfaces.

BE CAREFUL! The transceiver rear panel will become hot when operating continuously for long periods.

Place the transceiver in a secure place to avoid inadvertent use by children.

BE CAREFUL! The transceiver, HM-137 and optional HM-134 employ waterproof construction, which corresponds to JIS waterproof specification, Grade 7 (1 m/30 min.). However, once the transceiver or microphone has been dropped, waterproofing cannot be guaranteed due to the fact that the case may be cracked, or the waterproof seal damaged, etc.

◆ PRIORITIES

- Read all rules and regulations pertaining to priorities and keep an up-to-date copy handy. Safety and distress calls take priority over all others.
- You must monitor Channel 16 when you are not operating on another channel.
- False or fraudulent distress signals are prohibited and punishable by law.

◆ PRIVACY

- Information overheard but not intended for you cannot lawfully be used in any way.
- Indecent or profane language is prohibited.

◆ RADIO LICENSES

(1) SHIP STATION LICENSE

You must have a current radio station license before using the transceiver. It is unlawful to operate a ship station which is not licensed.

Inquire through your dealer or the appropriate government agency for a Ship-Radiotelephone license application. This government-issued license states the call sign which is your craft's identification for radio purposes.

(2) OPERATOR'S LICENSE

A Restricted Radiotelephone Operator Permit is the license most often held by small vessel radio operators when a radio is not required for safety purposes.

The Restricted Radiotelephone Operator Permit must be posted or kept with the operator. Only a licensed radio operator may operate a transceiver.

However, non-licensed individuals may talk over a transceiver if a licensed operator starts, supervises, ends the call and makes the necessary log entries.

Keep a copy of the current government rules and regulations handy.

■ Panel description

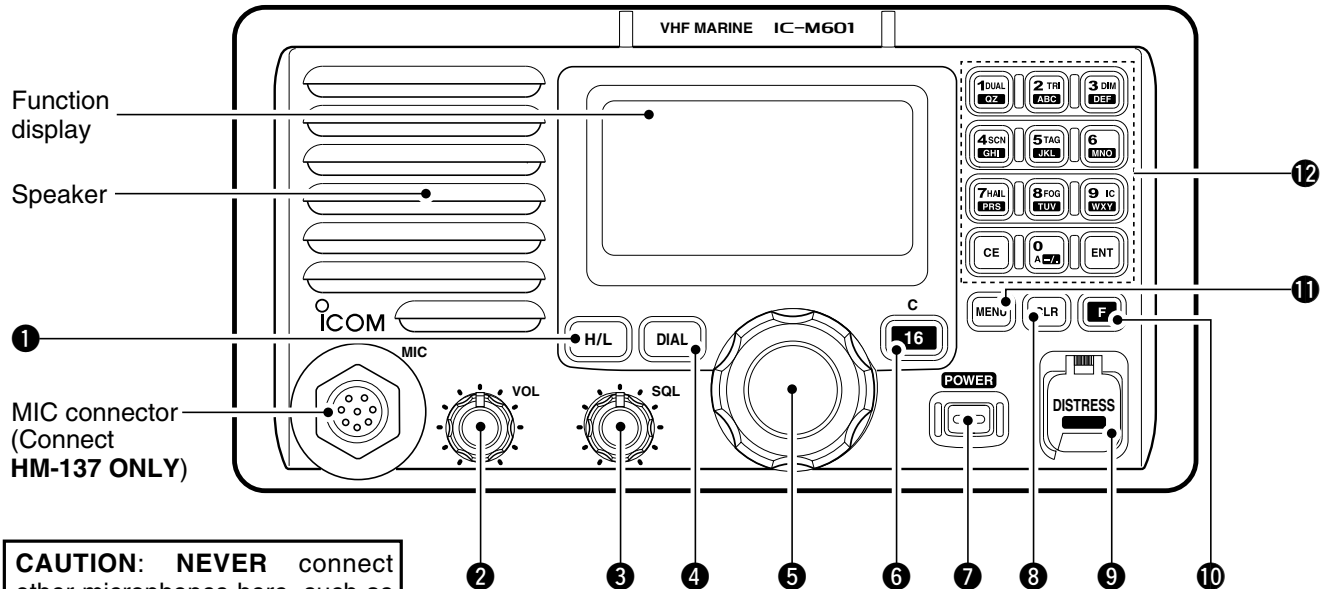

CAUTION: NEVER connect other microphones here, such as the optional HM-134, may cause damage to the transceiver.

❶ TRANSMIT POWER SWITCH [H/L]

- ➔ Toggles high or low power when pushed. (p. 10)
 - Some channels are set to low power only.
- ➔ While pushing this switch, some switches perform secondary function.

❷ VOLUME CONTROL [VOL] (p. 10)

Adjusts the audio level.

❸ SQUELCH CONTROL [SQL] (p. 10)

Sets the squelch threshold level.

❹ DIAL SWITCH [DIAL] (p. 9)

- ➔ Exits from Channel 16 or call channel when pushed momentarily. (p. 8)
- ➔ While pushing [H/L], push to select one of 2 regular channels in sequence. (p. 9)
 - International and U.S.A. channels are available for regular channels. (depends on version)

❺ CHANNEL SELECTOR [CHANNEL] (p. 10)

Rotate [CHANNEL] to select the operating channels, set mode contents, etc.

❻ CHANNEL 16/CALL CHANNEL SWITCH [16•C]

- ➔ Selects Channel 16 when pushed. (p. 8)
- ➔ Selects call channel when pushed for 1 sec. (p. 8)
 - "CALL" appears when call channel is selected.
- ➔ Push for 3 sec. to enter call channel programming condition when call channel is selected. (p. 11)
- ➔ While pushing [H/L], enters channel comment programming condition. (p. 11)
- ➔ While turning power ON, enters set mode when pushed and held. (p. 37)

❼ POWER SWITCH [POWER]

Push to turn the transceiver power ON or OFF.

❽ CLEAR SWITCH [CLR]

Push to cancel the entered function.

❾ DISTRESS SWITCH [DISTRESS] (p. 18)

Transmits distress call when pushed for 5 sec.

❿ FUNCTION SWITCH [F]

After pushing, activates the secondary functions.

- "F" appears when a secondary function can be accessed.

⓫ DSC MENU SWITCH [MENU] (p. 16)

- ➔ Toggles the DSC menu ON or OFF when pushed.

2 PANEL DESCRIPTION

⑫ KEYPAD

- Inputs numeral for channel number input, etc.
- Inputs numeral and alphabet (some symbol) for channel comment input.
- After pushing [F], turns the secondary function ON or OFF.
 - [3 DIM] is necessary to rotate [CHANNEL] after pushing.
 - Most of secondary function (except [5 TAG], [8 FOG]) can be cleared or cancelled when push [CLR] (Ⓞ).

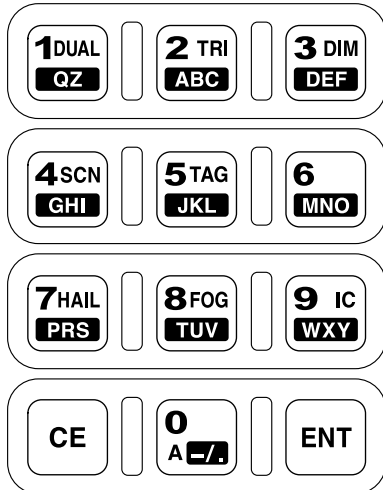

- Number input: '1'
- Comment input: '1,' 'Q,' 'Z,' 'q,' 'z' or space
- After pushing [F], turns the **DUALWATCH** function ON or OFF. (p. 13)



- Number input: '2'
- Comment input: '2,' 'A,' 'B,' 'C,' 'a,' 'b' or 'c'
- After pushing [F], turns the **TRI-WATCH** function ON or OFF. (p. 13)



- Number input: '3'
- Comment input: '3,' 'D,' 'E,' 'F,' 'd,' 'e' or 'f'
- After pushing [F], push this switch and rotate [CHANNEL] to adjust the brightness of the LCD and switch backlight.



- Number input: '4'
- Comment input '4,' 'G,' 'H,' 'I,' 'g,' 'h' or 'i'
- After pushing [F], starts or stops the **SCAN** function. (p. 15)



- ➔ Number input: '5'
- ➔ Comment input: '5,' 'J,' 'K,' 'L,' 'j,' 'k' or 'l'
- ➔ After pushing [F], sets the displayed channel as a tag (scanned) channel. (p.15)
- ➔ While pushing [H/L], push for 3 sec. to clear all tag channels. (p.15)



- ➔ Number input: '6'
- ➔ Comment input: '6,' 'M,' 'N,' 'O,' 'm,' 'n' or 'o'
- ➔ No secondary function



- ➔ Number input: '7'
- ➔ Comment input: '7,' 'P,' 'R,' 'S,' 'p,' 'r' or 's'
- ➔ After pushing [F], turns the **HAILER** function ON or OFF. (p. 33)



- ➔ Number input: '8'
- ➔ Comment input: '8,' 'T,' 'U,' 'V,' 't,' 'u' or 'v'
- ➔ After pushing [F], turns the **AUTOMATIC FOGHORN** function ON or OFF. (p. 34)



- ➔ Number input: '9'
- ➔ Comment input: '9,' 'W,' 'X,' 'Y,' 'w,' 'x' or 'y'
- ➔ After pushing [F], turns the **INTERCOM** function ON or OFF. (p. 36)



- ➔ Number input: '0'
- ➔ Number input: Push for 1 sec. to edit 'A.'
 - Inputting "A" for simplex channels.
- ➔ Comment input: '0' and symbols ('-' '/' '.')
- ➔ No secondary function



Fixes input of channel number and channel comment, etc.



Clears entered digits and retrieves the previous channel or channel comment during setting.

2 PANEL DESCRIPTION

■ Function display

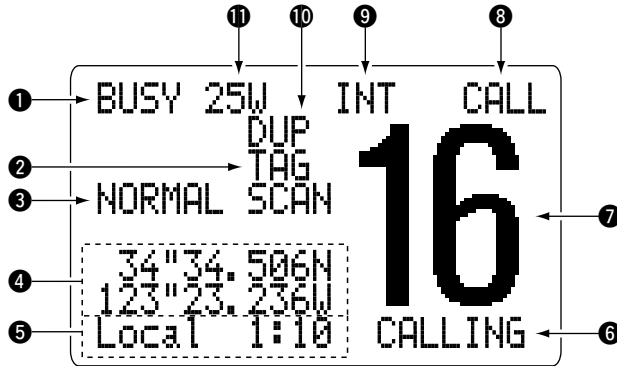

- 1 BUSY/TRANSMIT INDICATOR** (p. 10)
 - ➔ "BUSY" appears when receiving a signal or when the squelch opens.
 - ➔ "TX" appears while transmitting.
- 2 TAG CHANNEL INDICATOR** (p. 15)

Appears when a tag channel is selected.

3 SCAN INDICATOR

- ➔ Either "NORMAL SCAN" or "PRI-SCAN 16" scan type appears while scanning. (p. 15)
- ➔ "DUAL 16" appears during dualwatch; "TRI 16" appears during tri-watch. (p. 13)

4 POSITION INDICATOR

- ➔ Shows the GPS position data.
 - "??" may blink every 2 sec. instead of position data; when the GPS position data is invalid. In such a case, the last position data is held for up to 23.5 hours.
 - "??" may blink every 2 sec. instead of position data 4 hours after the position data is input manually, up until 23.5 hours have past.
- ➔ "No Position" appears when no GPS receiver is connected and no position data is input manually.

5 TIME ZONE INDICATOR

- ➔ "Local" appears when the offset time data in the 'Set up' menu is entered. (p. 29)
- ➔ "No Time" appears when no GPS receiver is connected and no time data is input manually.

6 CHANNEL COMMENT INDICATOR

- Channel comment appears if programmed. (p. 11)
- “Low Batt.” flashes when the battery voltage drops to approx. 10 V DC or below.

7 CHANNEL NUMBER READOUT

- Indicates the selected operating channel number.
- “A” appears when a simplex channel is selected. (p. 9)
 - “F” appears when [F] is pushed.

8 CALL CHANNEL INDICATOR (p. 8)

“CALL” appears when the call channel is selected.

9 CHANNEL GROUP INDICATOR (p. 9)

Indicates whether an International “INT” or U.S.A. “USA” channel is selected. (depends on version)

10 DUPLEX INDICATOR (p. 9)

- Appears when a duplex channel is selected.
- Duplex channel has a different transmit frequency and receiving frequency.

11 POWER INDICATOR (p. 10)

- “25W” appears when high power is selected.
- “1W” appears when low power is selected.

Microphone (HM-137)

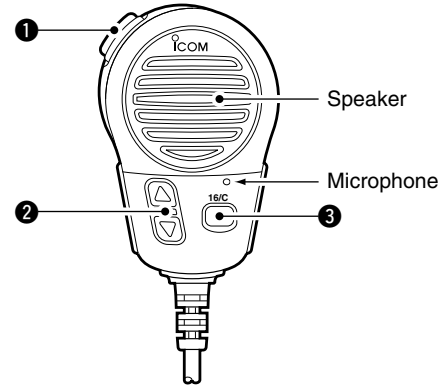

1 PTT SWITCH [PTT] (p. 10)

Push and hold to transmit; release to receive.

2 CHANNEL UP/DOWN SWITCHES [▲]/[▼] (p. 10)

Push either switch to change the operating channel, set mode contents, etc.

3 CHANNEL 16/CALL CHANNEL SWITCH [16/C]

- Push to select Channel 16; push for 1 sec. to Channel 9. (p. 8)
- While pushing [16/C], turn power ON to toggle the lock function ON or OFF. (p. 35)

■ Channel selection

◇ Channel 16

Channel 16 is the distress and safety channel. It is used for establishing initial contact with another station and for emergency communications. Channel 16 is monitored during both dualwatch and tri-watch. While standing by, you must monitor Channel 16.

- Push [16•C] momentarily to select Channel 16.
- Push [DIAL] to return to the condition before selecting Channel 16, or rotate [CHANNEL] to select operating channel.

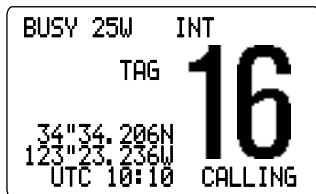

◇ Call channel

Each regular channel group has a separate leisure-use call channel. The call channel is monitored during tri-watch. The call channels can be programmed (p. 11) and are used to store your most often used channels in each channel group for quick recall.

- Push [16•C] for 1 sec. to select the call channel of the selected channel group.
 - "CALL" and call channel number appear.
 - Each channel group may have an independent call channel after programming a call channel.
- Push [DIAL] to return to the condition before selecting the call channel, or rotate [CHANNEL] to select an operating channel.

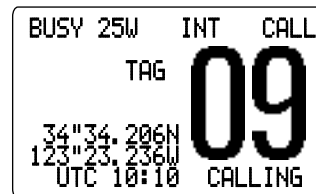
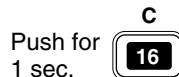

◆ **U.S.A. channels (depends on version) and International channels**

There are 58 U.S.A. channels in addition to 57 International channels. These channel groups may be specified for the operating area.

- ① Push [DIAL] to select a regular channel.
- ② While pushing [H/L], push [DIAL] to change the channel group, if necessary.
 - U.S.A. and International (INT) channels can be selected in sequence.
- ③ Rotate [CHANNEL] to select a channel.
 - "DUP" appears for duplex channels.
 - "A" appears for simplex channels.

Push H/L + DIAL

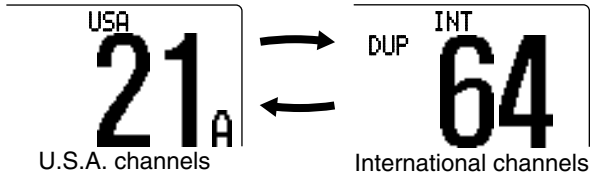

3 BASIC OPERATION

■ Receiving and transmitting

CAUTION: Transmitting without an antenna may damage the transceiver.

- ① Push [POWER] to turn power ON.
- ② Set the audio and squelch levels.
 - ➔ Rotate [SQL] fully counterclockwise in advance.
 - ➔ Rotate [VOL] to adjust the audio output level.
 - ➔ Rotate [SQL] clockwise until the noise disappears.
- ③ To change the channel group, push [DIAL] while pushing [H/L]. (p. 9)
- ④ Rotate [CHANNEL] or push [▲]/[▼] on the microphone to select the desired channel.
 - When receiving a signal, “BUSY” appears and audio is emitted from the speaker.
 - Further adjustment of [VOL] may be necessary at this point.
- ⑤ Push [H/L] to select the output power if necessary.
 - “25W” or “1W” appears when high or low power is selected, respectively.
 - Choose low power to reduce an intermodulation for other stations, choose high power for longer distance communications.
 - Some channels are for low power only.

- ⑥ Push and hold [PTT] to transmit, then speak into the microphone.
 - “TX” appears.
 - Channel 70 cannot be used for transmission.
- ⑦ Release [PTT] to receive.

IMPORTANT: To maximize the readability of your transmitted signal, pause a few sec. after pushing [PTT], hold the microphone 2.5 to 5 cm from your mouth and speak at a normal voice level.

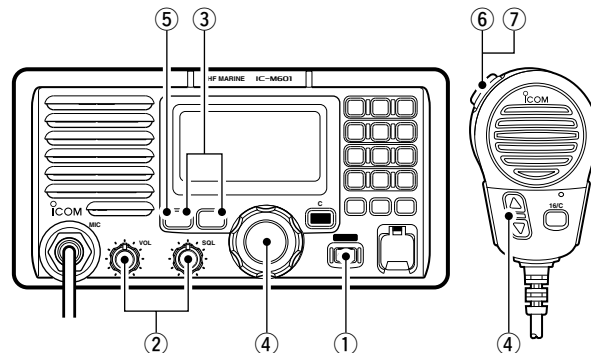

■ Call channel programming

The call channel is used to select Channel 9, however, you can program your most often-used channel in each channel group for quick recall.

- ① While pushing [H/L], push [DIAL] once or twice to select the desired channel group (U.S.A. and International) to be programmed. (depends on version)
- ② Push [16•C] for 1 sec. to select the call channel of the selected channel group.
 - “CALL” and call channel number appear.
- ③ Push [16•C] again for 3 sec. (until a long beep changes to 2 short beeps) to enter call channel programming condition.
 - Channel number starts blinking.
- ④ Rotate [CHANNEL] to select the desired channel.
- ⑤ Push [16•C] to program the displayed channel as the call channel.
 - Push [DIAL] to cancel.
 - The channel number stops blinking.

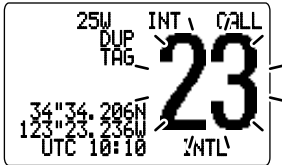
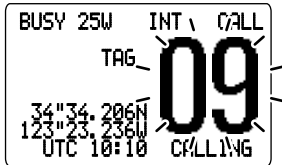

■ Channel comments

Memory channels can be tagged with alphanumeric names of up to 10 characters each.

Capital letters, small letters, numerals, some symbols (— . /) and space can be used.



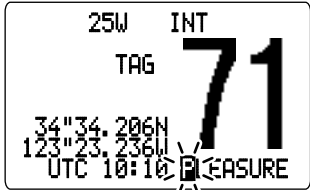







- ① Select the desired memory channel.
 - Cancel dual watch, tri-watch or scan in advance. (Push [CLR])
- ② While pushing [H/L], push [16•C] to edit the channel comment.
 - A cursor appears and blinks.



- ③ Push the appropriate key several times to enter the desired character.
 - See the table on page 12 for available characters.
 - Rotate [CHANNEL] or push [▲]/[▼] on the microphone to move the cursor.
- ④ Push [ENT] to input and set the comment.
 - Push [CLR] to cancel.
 - The cursor disappears.
- ⑤ Repeat steps ① to ④ to program other channel comments, if desired.

3 BASIC OPERATION

•Available characters

KEY	CHARACTERS	KEY	CHARACTERS
	1 Q Z q z (space)		6 M N O m n o
	2 A B C a b c		7 P R S p r s
	3 D E F d e f		8 T U V t u v
	4 G H I g h i		9 W X Y w x y
	5 J K L j k l		0 - / .

■ Description

Dualwatch monitors Channel 16 while you are receiving another channel; tri-watch monitors Channel 16 and the call channel while receiving another channel.

DUALWATCH/TRI-WATCH SIMULATION

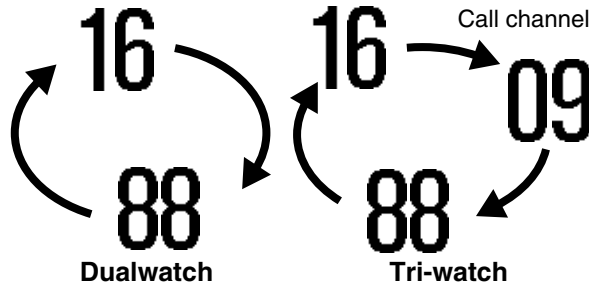

- If a signal is received on Channel 16, dualwatch/tri-watch pauses on Channel 16 until the signal disappears.
- If a signal is received on the call channel during tri-watch, tri-watch becomes dualwatch until the signal disappears.
- To transmit on the selected channel during dualwatch/tri-watch, push and hold [PTT].

■ Operation

- ① Select the desired operating channel.
- ② Push [F], then push [1 DUAL] to start dualwatch or [2 TRI] to start tri-watch.
 - “DUAL” appears during dualwatch; “TRI” appears during tri-watch.
 - A beep tone sounds when a signal is received on Channel 16.
- ③ To cancel dualwatch or tri-watch, push [CLR] or repeat step ②.

[Example]: Operating tri-watch on INT channel 25.

```

25W INT
  DUP
TRI 16
34"34, 206N
123"23, 236W
UTC 10:10
25 TELEPHONE
    
```

Tri-watch starts.

Signal is received on call channel.

```

BUSY 25W INT CALL
      TAG 16
TRI 16
34"34, 206N
123"23, 236W
UTC 10:10
09 CALLING
    
```

Signal received on Channel 16 takes priority.

```

BUSY 25W INT
  DUP
TRI >16<
34"34, 206N
123"23, 236W
UTC 10:10
25 TELEPHONE
    
```

Tri-watch resumes after the signal disappears.

```

25W INT
  DUP
TRI 16
34"34, 206N
123"23, 236W
UTC 10:10
25 TELEPHONE
    
```

■ Scan types

Scanning is an efficient way to locate signals quickly over a wide frequency range. The transceiver has priority scan and normal scan.

Set the tag channels (scanned channel) before scanning. Clear the tag channels which inconveniently stop scanning, such as those for digital communication use. (Refer to right page for details.)

/// Choose priority or normal scan in set mode. (p. 38)

PRIORITY SCAN

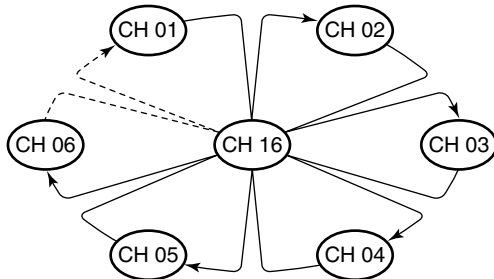

Priority scan searches through all tag channels in sequence while monitoring Channel 16. When a signal is detected on Channel 16, scan pauses until the signal disappears; when a signal is detected on a channel other than Channel 16, scan becomes dualwatch until the signal disappears.

NORMAL SCAN

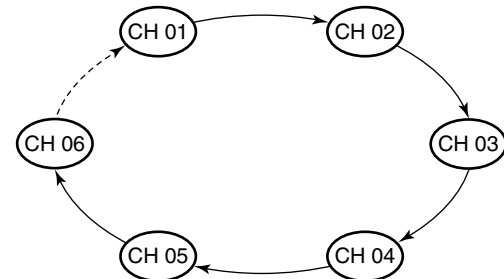

Normal scan, like priority scan, searches through all tag channels in sequence. However, unlike priority scan, Channel 16 is not checked unless Channel 16 is set as a tag channel.

■ Setting tag channels

For more efficient scanning, add desired channels as tag channels or clear tag channels for unwanted channels. Channels set as non-tag channels will be skipped during scanning. Tag channels can be assigned to each channel group (U.S.A. and International) independently.

- ① While pushing [H/L], push [DIAL] once or twice to select the desired channel group, if desired. (depends on version)
- ② Select the desired channel to set as a tag channel.
- ③ Push [**F**], then push [5 TAG] to set the displayed channel as a tag channel.
 - “TAG” appears in the display.
- ④ To cancel the tag channel setting, repeat step ③.
 - “TAG” disappears.

• Clearing all tag channels in the selected channel group

- ➔ While pushing [H/L], push [5 TAG] for 3 sec. to clear all tag channels in the channel group.

[Example]: Starting a normal scan.

The diagram illustrates the process of starting a normal scan in three stages:

- Initial State:** The display shows "25W INT", "DUP TAG", and a large "23". Below this, it lists "34"34.206N", "123"23.236W", and "UTC 10:10 INTL". An arrow points to the right with the instruction "Push [F] then [4 SCN]".
- Scan starts:** The display shows "25W INT", "DUP TAG", and "NORMAL SCAN". A large "00" is displayed with radiating lines. Below this, it lists "34"34.206N", "123"23.236W", and "UTC 10:10". An arrow points to the right.
- When a signal is received:** The display shows "BUSY 25W INT", "DUP TAG", and "NORMAL SCAN". A large "05" is displayed. Below this, it lists "34"34.206N", "123"23.236W", and "UTC 10:10".

■ Starting a scan

Set scan type (priority or normal scan) and scan resume timer in advance using set mode. (p. 38)

- ① While pushing [H/L], push [DIAL] once or twice to select the desired channel group, if desired.
- ② Set tag channels as described at left.
- ③ Make sure the squelch is closed to start a scan.
- ④ Push [**F**], then push [4 SCN] to start priority or normal scan.
 - “PRI-SCAN 16” or “NORMAL SCAN” appears in the function display.
 - When a signal is detected, scan pauses until the signal disappears or resumes after pausing 5 sec. according to set mode setting. (Channel 16 is still monitored during priority scan.)
 - Rotate [CHANNEL] to check the scanning tag channels, to change the scanning direction or resume the scan manually.
 - “16” blinks and a beep tone sounds when a signal is received on Channel 16 during priority scan.
- ⑤ To stop the scan, push [CLR] or repeat step ④.

■ MMSI code programming

The 9-digit MMSI (Maritime Mobile Service Identity: DSC self ID) code can be programmed at power ON.

/// **This code programming can be performed only once.**

- ① Turn power OFF.
- ② While pushing [MENU], turn power ON to enter MMSI code programming condition.
- ③ After the display appears, release [MENU].
- ④ Push [MENU] to enter the DSC menu.
- ⑤ Rotate [CHANNEL] to select "Set up," push [ENT].
- ⑥ Rotate [CHANNEL] to select "MMSI check," push [ENT].



- ⑦ Edit the specific MMSI code directly with the keypad.
 - Rotate [CHANNEL] to move the cursor backward or forward.
- ⑧ After input the 9-digit code, push [ENT] to set the code.
 - Returns to the set up menu.
- ⑨ Rotate [CHANNEL] to select "Exit," push [ENT].
 - Returns to the DSC menu.
 - Repeat again to return to the normal operation condition.

■ Position and time programming

A distress call should include the ship's position and time data. If no GPS is connected, your position and UTC (Universal Time Coordinated) time should be input manually. They are included automatically when a GPS receiver (NMEA0183 ver. 2.0) is connected.

/// This manual programming is not available when a GPS receiver (NMEA0183 ver. 2.0) is connected.

- ① Push [MENU] to enter the DSC menu.
- ② Rotate [CHANNEL] to select "Position Input," push [ENT].

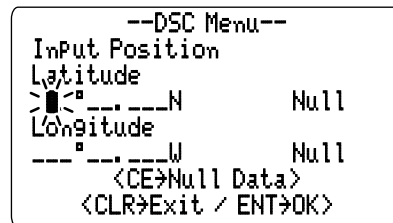

- ③ Edit the digit of your latitude data directly with the keypad.
 - Push [6•MNO] to edit N; North latitude or [7•PRS] to edit S; South latitude.
 - Rotate [CHANNEL] to move the cursor backward or forward.
 - Push [CE] to clear the position data.

- ④ Edit the digit of your longitude data directly with the keypad.
- Push [3•DEF] to edit E; East longitude or [9•WXY] to edit W; West longitude.
 - Rotate [CHANNEL] to move the cursor backward or forward.
 - Push [CE] to clear the position data.
- ⑤ Push [ENT] to set the position and advance to the time setting condition.
- Push [CLR] to abandon the setting and exit the condition to the DSC menu.

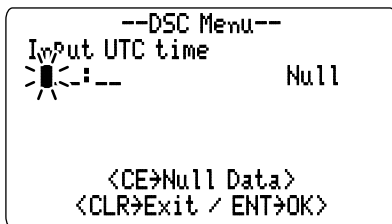

- ⑥ Edit the digit of the current UTC time directly with the keypad.
- Rotate [CHANNEL] to move the cursor backward or forward.
 - Push [CE] to clear the time.
- ⑦ Push [ENT] to set the time.
- Push [CLR] to abandon the setting and exit the condition.

■ Position indication

When a GPS receiver (NMEA0183 ver. 2.0) is connected, the transceiver displays the current position and time. When no GPS receiver is connected, the transceiver displays the manually entered position and time.

A GPS receiver appropriate for the IC-M601 is not supplied from Icom. A GPS receiver with NMEA0183 ver. 2.0 format is required for position indication. Ask your dealer about suitable GPS receivers.

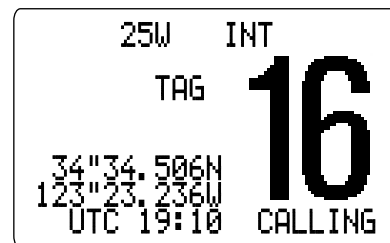

6 DSC OPERATION

■ Distress call

A distress call should be transmitted, if in the opinion of the Master, the ship or a person is in distress and requires immediate assistance.

NEVER USE THE DISTRESS CALL WHEN YOUR SHIP IS NOT IN AN EMERGENCY. A DISTRESS CALL CAN BE USED ONLY WHEN IMMEDIATE HELP IS NEEDED.

- ① Confirm no distress call is being received.
- ② While lifting up the switch cover, push [DISTRESS] for 5 sec. to transmit the distress call.
 - An emergency channel (Ch 70) is automatically selected and the distress call is transmitted.
 - Input the nature of distress call, if possible. (see p.23 Setting the distress information)
 - When no GPS is connected, input your position and UTC time, if possible.

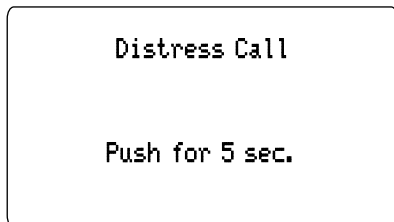

Distress Call

Push for 5 sec.

- ③ After transmitting the distress call, the transceiver waits for an acknowledgment call on Ch 70.
 - The distress call is automatically transmitted every 3.5 to 4.5 minutes.

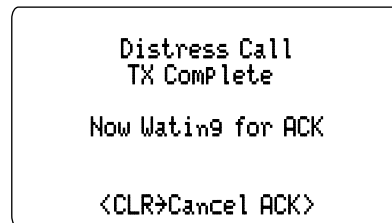

Distress Call
TX Complete

Now Waiting for ACK

<CLR>Cancel ACK

- ④ After 5 sec., the transceiver is set to Channel 16 automatically.

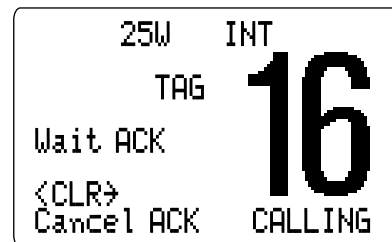

25W INT
TAG

Wait ACK

<CLR>
Cancel ACK

16
CALLING

- ⑤ When receiving the acknowledgment, reply using the microphone.

```

25W   INT
      TAG
Received
DistressACK
<Osaka Bay
>Chuck3
<CLR>Exit> 16 CALLING

```

- A distress alert contains (default);
 - Nature of distress: Undesignated distress
 - Position data : GPS or manual input position data held for 23.5 hrs.
- The distress call is repeated every 3.5–4.5 min., until receiving an 'acknowledgement.'
- Push [DISTRESS] to transmit a renewed distress call, if required.
- Push [CLR] to cancel the 'Call repeat' mode.
- "??" may blink instead of position and time indications when the GPS data is invalid, or has not been updated after 4 hours the position and time data input manually.

■ Transmitting DSC calls

◇ Transmitting Individual call

The individual call function allows you to transmit a DSC signal to a specific ship only.

- ① Push [MENU] to enter the DSC menu.
- ② Rotate [CHANNEL] to select "Individual Call," push [ENT].

```

--DSC Menu--
Select item
→Individual Call
  Group Call
  All Ships Call
  Received Calls
  Distress Settin9
  Set up

```

6 DSC OPERATION

- ③ Rotate [CHANNEL] to select the desired pre-programmed individual address or "Manual Input," push [ENT].
- The ID code for the individual call can be set in advance. (p. 24)
 - When "Manual Input" is selected, set the 9-digit ID code for the individual you wish to call with the keypad.

```
--DSC Menu--
Select Address
Manual InPut
John
Margaret
→Ricky

<CLR>Exit / <ENT>OK>
```

- ④ Rotate [CHANNEL] to select a desired intership channel or "Manual Input," push [ENT].
- Intership channels are already preset into the transceiver in recommending order.
 - When "Manual Input" is selected, rotate [CHANNEL] to select the desired channel other than Channel 70.

```
--DSC Menu--
Select Intership CH
→08
69
77
06

<CLR>Exit / <ENT>OK>
```

- ⑤ Push [ENT] to transmit the individual call.
- If Channel 70 is busy, the transceiver stands by until the channel becomes clear.

<pre>--DSC Menu-- Individual Call Ready <CLR>Exit / <ENT>OK></pre>	<pre>--DSC Menu-- Individual Call CH70 BUSY <CLR>Exit></pre>
--	---

Push [ENT] to transmit DSC call.

When Ch 70 is busy.

- ⑥ Standby on Channel 70 until an acknowledgement is received.

```
--DSC Menu--
Individual Call
TX Complete

Now Waiting for ACK

<CLR>Exit>
```

- ⑦ When the acknowledgement is received, the display changes to the previously selected channel with beeps.
- ⑧ Push and hold [PTT] to communicate to the responding ship.

◆ Transmitting Group call

The Group call function allows you to transmit a DSC signal to a specific group only.

- ① Push [MENU] to enter the DSC menu.
- ② Rotate [CHANNEL] to select "Group Call," push [ENT].

```

--DSC Menu--
Select item
Individual Call
→Group Call
All Ships Call
Received Calls
Distress Setting
Set up
  
```

- ③ Rotate [CHANNEL] to select the desired pre-programmed group address or "Manual Input," push [ENT].
 - The ID code for the group call can be set in advance. (p. 26)
 - When "Manual Input" is selected, set the 8-digit ID code for the group you wish to call with keypad.

```

--DSC Menu--
Select Address
Manual Input
I-com
Osaka
→Tokyo

<CLR>Exit / <ENT>OK>
  
```

- ④ Rotate [CHANNEL] to select a desired intership channel or "Manual Input," push [ENT].
 - Intership channels are already preset into the transceiver in recommending order.
 - When "Manual Input" is selected, rotate [CHANNEL] to select the desired channel other than Channel 70.
- ⑤ Push [ENT] to transmit the group call.
 - If Channel 70 is busy, the transceiver stands by until the channel becomes clear.

```

--DSC Menu--
Group Call ready

<CLR>Exit / <ENT>OK>
  
```

- ⑥ After the group call has been transmitted, the following indication is displayed.

```

--DSC Menu--
Group Call
TX Complete

<CLR>Exit>
  
```

- ⑦ Push [CLR] to exit the condition and the display changes to previously selected channel.
 - Even if [CLR] hasn't been pushed, the display automatically changes to previously selected channel.

6 DSC OPERATION

◆ Transmitting All ships call

Large ships use Channel 70 as their 'listening channel.' When you want to announce a message to these ships, use the 'all ships call' function.

- ① Push [MENU] to enter the DSC menu.
- ② Rotate [CHANNEL] to select "All Ships Call," push [ENT].

```
      --DSC Menu--  
Select item  
  Individual Call  
  Group Call  
  →All Ships Call  
  Received Calls  
  Distress Setting  
  Set up
```

- ③ Rotate [CHANNEL] to select the desired category, push [ENT].

```
      --DSC Menu--  
Select Category  
  →Routine  
  Safety  
  Urgency
```

- ④ Push [ENT] to transmit the all ships call.
 - Channel 70 is selected and the all ships call is transmitted.

```
      --DSC Menu--  
All Ships Call Ready  
  
  <CLR>Exit / ENT→OK
```

- ⑤ After the all ships call has been transmitted, the following indication is displayed.

```
      --DSC Menu--  
All Ships Call  
TX Complete  
  
  <CLR>Exit
```

- ⑥ Push [CLR] to exit the condition and the display changes to Channel 16.
 - Even if [CLR] hasn't been pushed, the display automatically changes to Channel 16 after 5 sec. of inactivity.

■ Setting the distress information

The nature of the distress call should be included in the distress call.

- ① Push [MENU] to enter the DSC menu.
- ② Rotate [CHANNEL] to select "Distress Setting," push [ENT].

```

--DSC Menu--
Select item
  Group Call
  All Ships Call
  Received Calls
  →Distress Setting
  Set up
  Exit
  
```

- ③ Rotate [CHANNEL] to select the nature of the distress, push [ENT].
 - 'Undesignated,' 'Explosion,' 'Flooding,' 'Collision,' 'Grounding,' 'Capsizing,' 'Sinking,' 'Adrift (Disable adrift),' 'Abandoning (Abandoning ship),' 'Piracy (Piracy attack),' and 'MOB (Man overboard)' are available.

```

--DSC Menu--
Select Nature
  Undesignated
  →Explosion
  Flooding
  Collision
  Grounding
  Capsizing
  Sinking
  Adrift
  Abandoning
  Piracy
  MOB

<CLR>Exit / ENT→OK>
  
```

- ④ When no GPS is connected or GPS data is invalid, the position information appears. Set the current position, then push [ENT].
 - Edit the digit of your position data directly with the keypad.
 - Push [6•**MNO**] to edit N; North latitude or [7•**PRS**] to edit S; South latitude.
 - Push [3•**DEF**] to edit E; East longitude or [9•**WXY**] to edit W; West longitude.
 - Rotate [CHANNEL] to move the cursor backward or forward.
 - Push [CE] to clear the position data.

6 DSC OPERATION

```
--DSC Menu--
Input Position
Latitude
>|<°-----N      Null
Longitude
-----°W      Null
      <CE>Null Data>
      <CLR>Exit / ENT>OK>
```

- ⑤ The time information appears. Set the current UTC time, push [ENT].

- Edit the digit of the current UTC time directly with the keypad.
- Push [CLR] to abandon the setting and exit the condition to selecting the nature menu.
- Rotate [CHANNEL] to move the cursor backward or forward.
- Push [CE] to clear the time.

```
--DSC Menu--
Input UTC time
>|<:--      Null
      <CE>Null Data>
      <CLR>Exit / ENT>OK>
```

- ⑥ Push [DISTRESS] for 5 sec. to transmit the distress call.
- The selected nature of the distress is stored for 10 minutes.

■ DSC individual ID

A total of 100 DSC address IDs can be programmed and named with up to 10 characters.

◆ Programming Address ID

- ① Push [MENU] to enter the DSC menu.
- ② Rotate [CHANNEL] to select "Set up," push [ENT].

```
--DSC Menu--
Select item
Group Call
All Ships Call
Received Calls
Distress Setting9
>Set up
Exit
```

- ③ Rotate [CHANNEL] to select "Add: INDU ID," push [ENT].

```
--DSC Menu--
Set up
>Add:INDU ID
Add:Group ID
DEL:INDU ID
DEL:Group ID
Offset time
MMSI Check
```

④ Set the individual ID and ID name.

- Edit the 9-digits of the appropriate distress ID directly with the keypad.
- Push keypad several times to edit the character.
- Rotate [CHANNEL] to move the cursor backward or forward.
- Push [CE] to clear the ID and ID name.
- Push [CLR] to cancel and exit the condition to the set up menu.

```

--DSC Menu--
Add: Individual ID
Input 9 digits
->|-----
Input name
-----

```

⑤ Push [ENT] to program and exit the condition to the set up menu.

◆ Deleting address ID

- ① Push [MENU] to enter the DSC menu.
- ② Rotate [CHANNEL] to select "Set up," push [ENT].
- ③ Rotate [CHANNEL] to select "DEL: INDU ID," push [ENT].
 - When no address ID is programmed, the transceiver exits the condition to the set up menu automatically.

```

--DSC Menu--
Set up
Add: INDU ID
Add: Group ID
DEL: INDU ID
->DEL: Group ID
Offset time
MMSI Check

```

④ Rotate [CHANNEL] to select the desired ID name for deleting.

```

--DSC Menu--
Select ID
Turtle
->John
Margaret
Ricky

<CLR>Exit / <ENT>OK>

```

⑤ Push [ENT] to delete the address ID and exit the condition.

6 DSC OPERATION

◆ Programming Group ID

- ① Push [MENU] to enter the DSC menu.
- ② Rotate [CHANNEL] to select "Set up," push [ENT].

```
--DSC Menu--
Select item
Group Call
All Ships Call
Received Calls
Distress Settin9
->Set up
Exit
```

- ③ Rotate [CHANNEL] to select "Add: Group ID," push [ENT].

```
--DSC Menu--
Set up
Add:INDU ID
->Add:Group ID
DEL:INDU ID
DEL:Group ID
Offset time
MMSI Check
```

- ④ Set the group ID and ID name.
 - Edit the 8-digits of the group ID directly with the keypad.
 - Push the appropriate keypad several times to edit the character.
 - Rotate [CHANNEL] to move the cursor backward or forward.
 - Push [CE] to clear the ID and name.
 - Push [CLR] to cancel and exit the condition to the set up menu.

```
--DSC Menu--
Add:Individual ID
Input 8 digits
[ENT]
Input name
-----
```

- ⑤ Push [ENT] to program and exit the condition to DSC set up menu.

◆ Deleting group ID

- ① Push [MENU] to select the DSC menu.
- ② Rotate [CHANNEL] to select "Set up," push [ENT].
- ③ Rotate [CHANNEL] to select "DEL: Group ID," push [ENT].
 - When no group ID is programmed, the transceiver exits the condition to the set up menu automatically.

```
--DSC Menu--
Set up
Add:INDU ID
Add:Group ID
DEL:INDU ID
->DEL:Group ID
Offset time
MMSI Check
```

- ④ Rotate [CHANNEL] to select the desired ID name for deleting.
- ⑤ Push [ENT] to delete the group ID and exit the condition DSC set up menu.

■ Receiving DSC calls

◇ Receiving a distress call

While monitoring Channel 70 and a distress call is received:

- The emergency alarm sounds for 2 minutes.
 - Push any switch to stop the alarm.
- “Received Distress” appears in the display, then Channel 16 is automatically selected.
- Continue monitoring Channel 16 as a coast station may require assistance.

```

25W INT
TAG
Received Distress
<Chuck3>
<CLR>Exit CALLING
16

```

◇ Receiving a distress acknowledgement

While monitoring Channel 70 and a distress acknowledgement to other ship is received:

- The emergency alarm sounds for 2 minutes.
 - Push any switch to stop the alarm.
- “Received Distress ACK” appears in the display, then Channel 16 is automatically selected.

```

25W INT
TAG
Received DistressACK
<Osaka Bay>
>Chuck3
<CLR>Exit CALLING
16

```

◇ Receiving an all ships call

While monitoring Channel 70 and an all ships call is received:

- The emergency alarm sounds when the category is ‘Distress’ or ‘Urgency’; 3 beeps sound for other categories.
- “Received All Ships” appears in the display, then Channel 16 is automatically selected for voice communication.
- Monitor channel 16 for an announcement from the calling vessel.

```

25W INT
TAG
Received All Ships
<Chuck3>
<CLR>Exit CALLING
16
<CLR>OK

```

6 DSC OPERATION

◇ Receiving an individual call

While monitoring Channel 70 and an individual call is received:

- The emergency alarm or beeps sound depending on the received category.
- "Received Individual" appears in the display.
- Push [ENT] to change to the channel specified by the calling station for voice communication; push [CLR] to ignore the individual call.

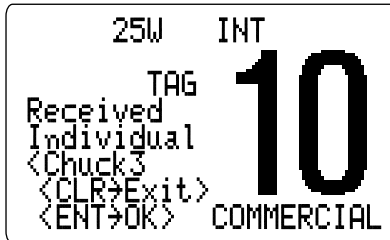

◇ Receiving a group call

While monitoring Channel 70 and an group call is received:

- The emergency alarm or beeps sound depending on the received category.
- "Received Group" appears in the display.
- Push [ENT] to change to the channel specified by the calling station for voice communication; push [CLR] to ignore the individual call.

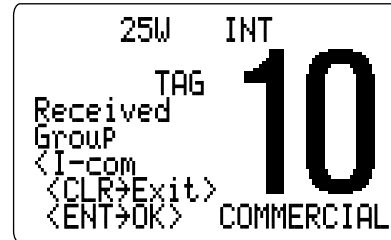

■ DSC set mode

◇ Offset time

This item sets the offset time from the UTC (Universal Time Coordinated) time.

- ① Push [MENU] to enter the DSC menu.
- ② Rotate [CHANNEL] to select "Set up," push [ENT].

```

--DSC Menu--
Select item
Group Call
All Ships Call
Received Calls
Distress Setting
→Set up
Exit
  
```

- ③ Rotate [CHANNEL] to select "Offset time," push [ENT].

```

--DSC Menu--
Set up
Add:INDU ID
Add:Group ID
DEL:INDU ID
DEL:Group ID
→Offset time
MMSI Check
  
```

- ④ Set the offset time from the UTC (Universal Time Coordinated) time.
 - Edit the digit of offset time directly with the keypad.
 - Push [0] or [DEL] to edit or delete "—", when the cursor is on the first digit.
 - Rotate [CHANNEL] to move the cursor backward or forward.
 - Push [CE] to clear the time data.
 - Push [CLR] to cancel and exit the condition to the set up menu.

```

--DSC Menu--
Input Offset Time
|←|0:--
  
```

No offset time (default)

```

--DSC Menu--
Input Offset Time
-12:00
  
```

-12 hours

- ⑤ Push [ENT] to program and to exit the condition to the set up menu.

▨ The local time indication is not available when a GPS receiver (sentence formatter RMC) is input, the transceiver's display indicates UTC time only.

6 DSC OPERATION

◆ MMSI code check

The programmed 9-digit MMSI (DSC self ID) code can be checked in DSC set mode.

- ① Push [MENU] to enter the DSC menu.
- ② Rotate [CHANNEL] to select "Set up," push [ENT].

```
      --DSC Menu--  
Select item  
  Group Call  
  All Ships Call  
  Received Calls  
  Distress Setting  
→Set up  
  Exit
```

- ③ Rotate [CHANNEL] to select "MMSI check," push [ENT].

```
      --DSC Menu--  
Set up  
  Add:INDU ID  
  Add:Group ID  
  DEL:INDU ID  
  DEL:Group ID  
  Offset time  
→MMSI Check
```

- ④ Check the 9-digit MMSI (DSC self ID) code.

```
      --DSC Menu--  
MMSI Check  
123456789  
  
      <CLR>Exit>
```

- ⑤ Push [CLR] or [ENT] to exit the condition to the set up menu.

■ Received messages

The transceiver automatically stores up to 20 distress messages and 20 other messages. The messages can be used as an assistance to the logbook.

- ① Push [MENU] to select the DSC menu.
- ② Rotate [CHANNEL] to select "Received Calls," push [ENT].

```

--DSC Menu--
Select item
Group Call
All Ships Call
→Received Calls
Distress Setting
Set up
Exit
  
```

◇ Distress message

- ① Rotate [CHANNEL] to select "Distress," push [ENT].

```

--DSC Menu--
Select Message
→Distress
Other

<CLR>Exit / ENT→OK
  
```

- ② Rotate [CHANNEL] to scroll to the desired message, push [ENT].

•When some messages are blinking, the messages have not been read yet.

```

--DSC Menu--
Select Item
>16:00 Ricky
'14:55' Chuck3
→12:34 Smith

<CLR>Exit / ENT→OK
  
```

- ③ Rotate [CHANNEL] to scroll the message.

--DSC Menu--	--DSC Menu--
Distress <Chuck3 MOB LAT: 23°45.234N LON:123°45.456W	Distress MOB LAT: 23°45.234N LON:123°45.456W UTC: 8:00
<CLR>Exit /	<CLR>Exit / CE→Del

- ④ Push [CLR] to exit the condition or push [CE] to clear the displayed message and returns to DSC menu.

6 DSC OPERATION

◆ Other messages

- ① Rotate [CHANNEL] to select "Other," push [ENT].

```
      --DSC Menu--  
Select Message  
  Distress  
  →Other  
  
      <CLR>Exit / ENT→OK>
```

- ② Rotate [CHANNEL] to scroll to the desired message, push [ENT].

•When some messages are blinking, the messages have not been read yet.

```
      --DSC Menu--  
Select Message  
  Individual Call  
  'All Ships Call'  
  →Group Call  
  Individual Call  
  
      <CLR>Exit / ENT→OK>
```

- ③ Rotate [CHANNEL] to scroll the message.

•The stored message has various information and depending on the type of distress call.

<pre> --DSC Me Group Call <Chuck3 Routine >OSAKA-1 F3E simplex <CLR>Exit /</pre>	<pre> --DSC Menu-- Group Call Routine >OSAKA-1 F3E simplex CH10 <CLR>Exit / CE→Del></pre>
--	---

- ④ Push [CLR] to exit the condition or push [CE] to clear the displayed message and returns to DSC menu.

■ Hailer operation

The IC-M601 has a 2-way hailer function for voice amplification and reception over a loudspeaker, making it unnecessary to leave the bridge to hear a hailing party.

Connect an external hailer speaker (25 W or more/4Ω) as described on p. 41.

- Transmitting is not possible during hailer operation.
- The received signal is muted during hailer operation.

① Push [**F**], then push [7 HAIL] to enter hailer mode.



- ② Push and hold [PTT] and speak at a normal voice level into the microphone.
- “TALK” or “LISTEN” appears on the caller or listener function display, respectively.
 - To adjust the hailer level, rotate [CHANNEL].

③ After releasing [PTT] you can hear the response through the speaker.

④ To return to normal operation, push [CLR] or repeat step ①.

- While in the hailer mode, the transceiver functions (transmit and receive) are interrupted. If the transceiver is in transmit condition, the hailer function is not available.
- When a DSC call is received, the hailer function is interrupted with an automatic return to the transceiver mode. The transceiver's display indicates 'Receiving DSC calls.' (p. 27)

7 OTHER FUNCTIONS

■ Automatic foghorn

The automatic foghorn function sounds a horn repeatedly until the function is turned OFF. Four patterns are available for varying conditions.

The foghorn outputs from the hailer speaker. To use this function, the hailer speaker (25 W or more/4Ω) must be connected to the transceiver. See p.41 for connection details.

TYPE		PATTERN	USAGE
UNDERWAY	One 5-second blasts every 120 seconds.		Motor vessel underway and making way.
STOP	Two 5-second blasts (separated by 2 seconds) every 120 seconds.		Motor vessel underway but stopped (not making way).
SAIL	One 5-second blast followed by two 1-second blasts (each separated by 2 seconds) every 120 seconds.		Sailing vessel underway, fishing vessel (underway or anchored), vessel not under command, a vessel restricted in her ability to maneuver (underway or at anchor), or a vessel towing or pushing another ahead.
TOW	One 5-second blast followed by three 1-second blasts (each separated by 2-seconds) every 120 seconds.		Vessel under tow (manned).

/// The audio frequency of the foghorn is selectable. See p.39 for details on selecting the audio frequency.

- ① Push [F], then push [8 FOG] to enter automatic foghorn mode.
- ② Rotate [CHANNEL] to select the desired foghorn pattern, push [ENT].
 - 'UNDERWAY,' 'STOP,' 'SAIL,' 'TOW' are available. (p.34)
 - Even if [ENT] hasn't been pushed, the display automatically changes to the next step after 5 sec. of inactivity.

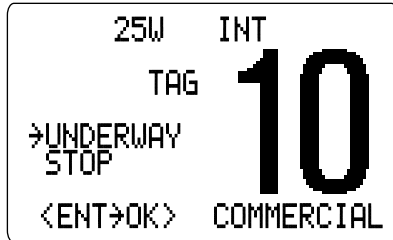

- ③ Rotate [CHANNEL] to adjust the foghorn level, push [ENT].
 - The foghorn level is adjustable in 7 steps.
 - Even if [ENT] hasn't been pushed, the display automatically changes to the next step after 5 sec. of inactivity.



- ④ To return to normal operation, repeat step ①.

When a DSC call is received, the automatic foghorn function is interrupted with an automatic return to the transceiver mode. The transceiver's display indicates 'Receiving DSC calls.' (p 27)

Microphone lock function

The microphone lock function electrically locks the [▲]/[▼] and [16/C] switches on the supplied microphone. This prevents accidental channel changes and accidental function access.

- ➔ While pushing [16/C] on the HM-137, turn power ON to toggle the lock function ON or OFF.

7 OTHER FUNCTIONS

■ Intercom operation

The optional intercom function allows you to talk with a distance place such as the deck from the cabin. The optional HM-134 REMOTE-CONTROL MICROPHONE is required for intercom operation.

Connect an optional HM-134 as described on p. 61.

- Transmitting is impossible during intercom operation.
- The received signal is muted during intercom operation.

- ① Push [**F**], then push [9 IC] to enter intercom mode.
 - The HM-134 power is automatically turned ON, even if the power is OFF.



IC-M601

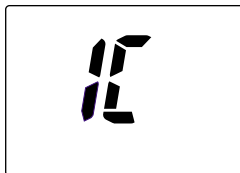

HM-134

- ② Push and hold [9 IC] again to call up.
 - The transceiver and microphone emit call beeps.

- ③ Push and hold [PTT] and speak at a normal voice level into the microphone.
 - "TALK" or "LISTEN" appears on the caller or listener function display, respectively.
 - To adjust the IC-M601's speaker output level, rotate [VOL].
 - To adjust the HM-134's speaker output level, push [▲]/[▼] after pushing [VOL].



IC-M601 (caller)



HM-134 (listener)

- ④ After releasing [PTT] you can hear the response through the speaker.
- ⑤ To return to normal operation, push [CLR] or repeat step ①.

- While in the intercom mode, the transceiver functions (transmit and receive) are interrupted. If the transceiver is in transmit condition, the intercom function is not available.
- When a DSC call is received, the intercom function is interrupted with an automatic return to the transceiver mode. The transceiver's display indicates 'Receiving DSC calls.' (p 27)

■ Set mode programming

Set mode is used to change the conditions of the transceiver's functions: scan type (normal or priority), scan resume timer, dual/tri-watch of COMMANDMIC, transceiver's beep tone, internal speaker, LCD contrast and automatic foghorn frequency.

⚡ Available functions may differ depending on dealer setting.

- ① Turn power OFF.
- ② While pushing [16•C], turn power ON to enter set mode.
- ③ After the display appears, release [16•C].
- ④ Rotate [CHANNEL] to select the desired item, push [ENT].
Or push [16•C] to select the item when using an optional HM-134.
- ⑤ Rotate [CHANNEL] to select the desired condition of the item. Use [▲]/[▼] when using an optional HM-134.
- ⑥ Rotate [CHANNEL] to select "Exit," push [ENT] to exit set mode and returns to normal operation condition

7
8

•SET MODE CONSTRUCTION

Rotate  [CHANNEL]

Push  when using HM-134

```

--Set Mode--
>Scan Type
Scan Timer
Dual/Tri COMMANDMIC
Beep
Internal Speaker
Contrast
Foghorn Frequency
Exit
    
```

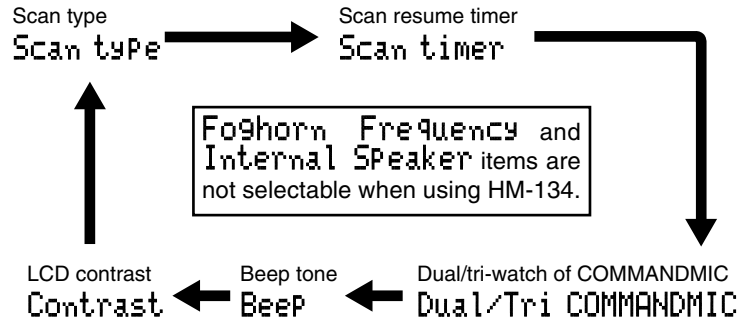

■ Set mode items

◇ Scan type

The transceiver has 2 scan types: normal scan and priority scan. Normal scan searches all tag channels in the selected channel group. Priority scan searches all tag channels in sequence while monitoring Channel 16.

```
      --Set Mode--  
Scan Type  
Priority  
→Normal  
  
      <ENT>OK>
```

(Default: Normal)

◇ Scan resume timer

The scan resume timer can be selected as a pause (OFF) or timer scan (ON). When OFF is selected, the scan pauses until the signal disappears. When ON is selected, the scan pauses 5 sec. and resumes even if a signal has been received on channels except for Channel 16.

```
      --Set Mode--  
Scan Timer  
ON  
→OFF  
  
      <ENT>OK>
```

(Default: OFF)

◇ Dual/Tri-watch of COMMANDMIC (Appears when connecting HM-134)

This item sets the HM-134's [DUAL•IC] switch function as dual watch or tri-watch.

```
      --Set Mode--  
Dual/Tri COMMANDMIC  
Tri-watch  
→Dualwatch  
  
      <ENT>OK>
```

(Default: Dualwatch)

◇ Beep tone

You can select silent operation by turning beep tones OFF, or you can have confirmation beeps sound at the push of a switch by turning beep tones ON.

```
      --Set Mode--  
Beep  
→ON  
OFF  
  
      <ENT>OK>
```

(Default: ON)

/// The optional HM-134 has it's own setting for the beep tone.

◇ Internal speaker

When an external speaker is connected and the transceiver's internal speaker is not required, the speaker on the transceiver and microphone can be deactivated.

```

--Set Mode--
Internal Speaker
→ON
OFF

<ENT>OK>

```

(Default: ON)

◇ LCD contrast

This item adjusts the contrast of the LCD in 8 steps.

```

--Set Mode--
Contrast
→5
4
3
2
1

<ENT>OK>

```

(Default: 5)

/// The optional HM-134 has it's own setting for the LCD contrast.

◇ Automatic foghorn frequency

The audio frequency of the automatic foghorn can be adjusted to suit your preference. While this item is selected, pushing [PTT] outputs the foghorn—experiment with the frequencies available until you find one you like.

• Available frequency range is 200 Hz to 850Hz in 50 Hz step.

```

--Set Mode--
Foghorn Frequency
→400
350
300
250
200

<ENT>OK>

```

(Default: 400)

■ Supplied accessories

The following accessories are supplied

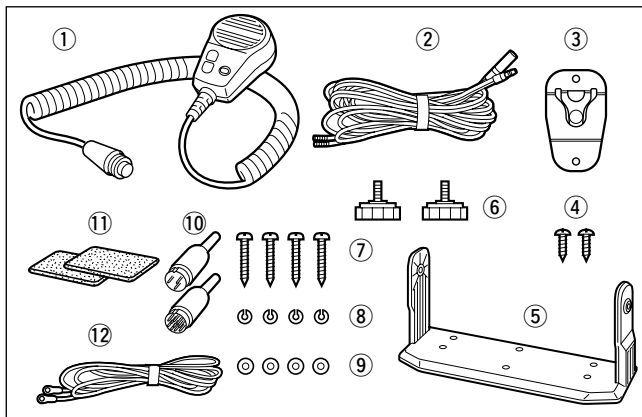

	Qty.
① Microphone (HM-137)	1
② DC power cable (OPC-1174)	1
③ Microphone hanger	1
④ Mic hanger screws (3 × 16)	2
⑤ Mounting bracket	1
⑥ Knob bolts for mounting bracket	2
⑦ Mounting screws (5 × 20)	4
⑧ Spring washers (M5)	4
⑨ Flat washers (M5)	4
⑩ Accessory connectors (3 pin, 10 pin)	1 each
⑪ Sponges	2
⑫ OPC-1096	1

■ Antenna

A key element in the performance of any communication system is an antenna. Ask your dealer about antenna and the best places to mount them.

■ Fuse replacement

One fuse is installed in the supplied DC power cable. If a fuse blows or the transceiver stops functioning, track down the source of the problem, if possible, and replace the damaged fuse with a new, rated one.

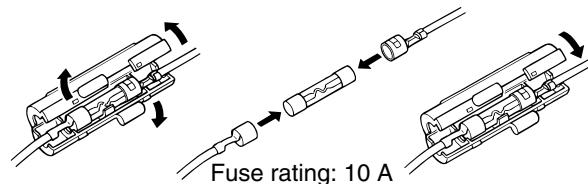

■ Cleaning

If the transceiver becomes dusty or dirty, wipe it clean with a soft, dry cloth.



AVOID the use of solvents such as benzene or alcohol, as they may damage transceiver surfaces.

■ Connections

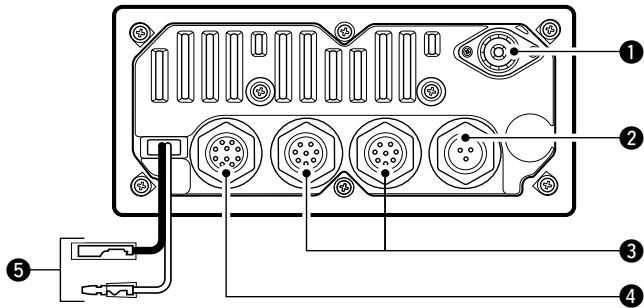

1 ANTENNA CONNECTOR

Connects a marine VHF antenna with a PL-259 connector.

CAUTION: Transmitting without an antenna may damage the transceiver.

2 HAILER/FOGHORN CONNECTOR

Connects to a hailer speaker (25 W or more/4Ω).



3 EXTERNAL MICROPHONE JACKS

Connects to optional HM-134 REMOTE-CONTROL MICROPHONE.

CAUTION: NEVER connect other microphones, such as the HM-137, may cause damage to the transceiver.

4 GPS RECEIVER/EXTERNAL SPEAKER JACK

Connects to a GPS receiver for position and time indications.

- An NMEA0183 ver. 2.0 (sentence formatters RMC, GGA, GNS, GLL) compatible GPS receiver is required. Ask your dealer about suitable GPS receivers.

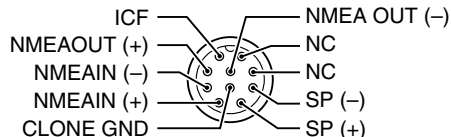

Connects to a PC or navigation equipment (NMEA0183 ver. 3.01 sentence formatters DSC, DSE compatible) for plotting received other ships position data.

Connects to an external speaker.

5 DC POWER CONNECTOR

Connects the supplied DC power cable from this connector to an external 13.8 V DC power source.

CAUTION: After connecting the DC power cable, cover the connectors with a rubber vulcanizing tape as shown below, to prevent water seeping into the transceiver.

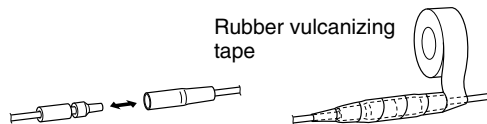

9 CONNECTIONS AND MAINTENANCE

■ Mounting the transceiver

◆ Using the supplied mounting bracket

The universal mounting bracket supplied with your transceiver allows overhead or onboard mounting.

- Mount the transceiver securely with the 4 supplied screws (M5 × 20) to a surface which is more than 10 mm thick and can support more than 5 kg.
- Mount the transceiver so that the face of the transceiver is at 90° to your line of sight when operating it.

CAUTION: KEEP the transceiver and microphone at least 1 meter away from your vessel's magnetic navigation compass.

NOTE:

- Check the installation angle; the function display may not be easy-to-read at some angles.
- When mounting the transceiver on the place that is prone to strong vibration, use the supplied sponges between the transceiver and mounting bracket for reducing the effect of the vibration.

• OVERHEAD MOUNTING

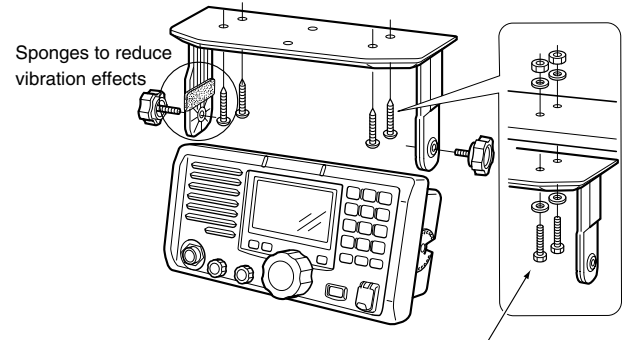

These screws are shown as mounting example only.
Not supplied with accessories.

• MOUNTING ON THE BOARD

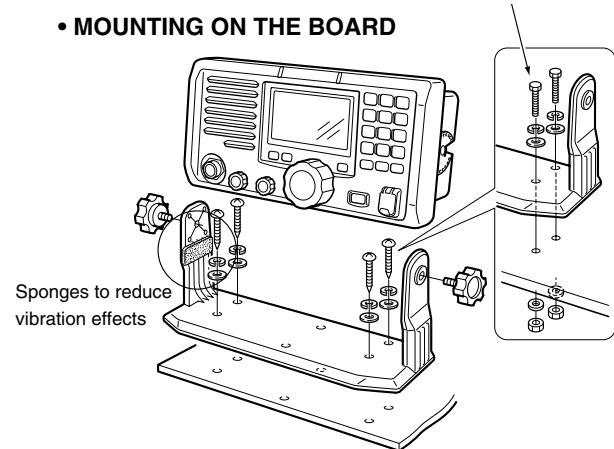

◆ Using the optional MB-75

An optional MB-75 FLUSH MOUNT is available for mounting the transceiver to a flat surface such as an instrument panel.

CAUTION: KEEP the transceiver and microphone at least 1 meter away from your vessel's magnetic navigation compass.

- ① Using the attached template, carefully cut a hole into the instrument panel (or wherever you plan to mount the transceiver).
- ② Slide the transceiver through the hole as shown below.

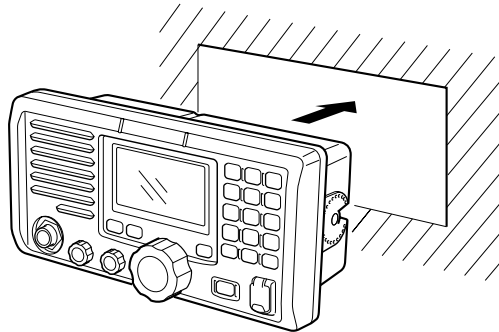

- ③ Attach the 2 supplied bolts (M5 × 8 mm) on either side of the IC-M601.

- ④ Attach the clamps on either side of the IC-M601.
 - Make sure that the clamps align parallel to the IC-M601's body.

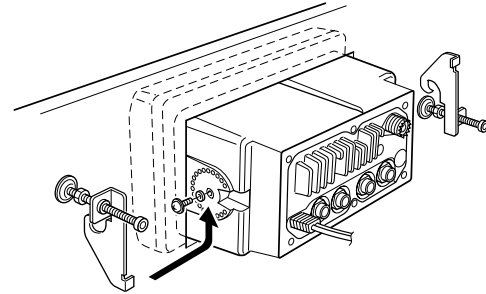

- ⑤ Tighten the end bolts on the clamps (rotate clockwise) so that the clamps press firmly against the inside of the instrument control panel.
- ⑥ Tighten the locking nuts (rotate counterclockwise) so that the IC-M601 is securely mounted in position as below.
- ⑦ Connect the antenna and control cable, then return the instrument control panel to its original place.

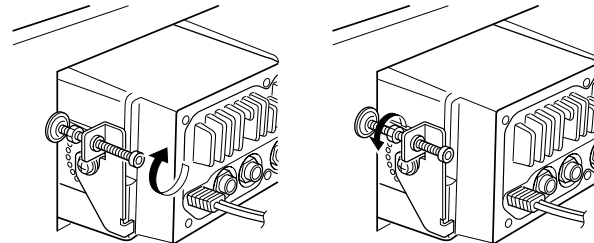

■ Dimensions

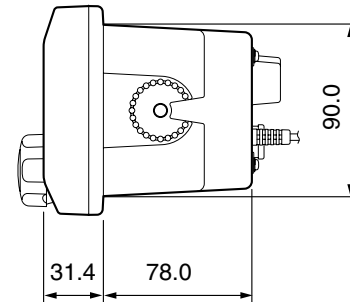
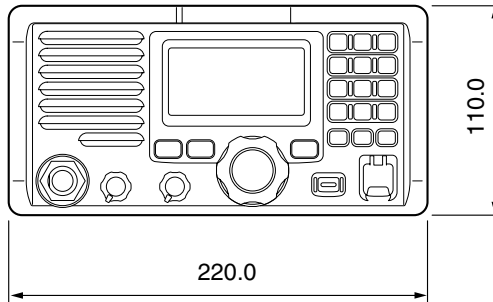
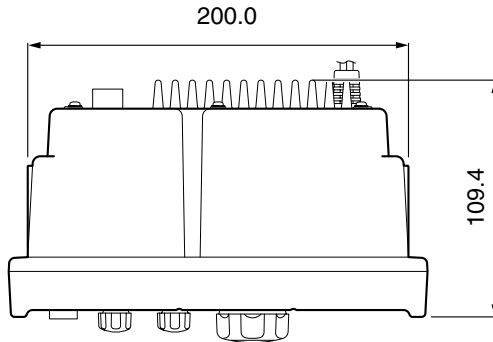

Unit: mm

TROUBLESHOOTING 10

PROBLEM	POSSIBLE CAUSE	SOLUTION	REF.
No power comes ON.	<ul style="list-style-type: none">•Bad connection to the power supply.	<ul style="list-style-type: none">•Check the connection to the transceiver.	p. 41
No sound comes from the speaker.	<ul style="list-style-type: none">•Squelch level is too deep.•Volume level is too low.•Speaker has been exposed to water.•Internal speaker is turned OFF.	<ul style="list-style-type: none">•Set squelch to the threshold point.•Set [VOL] to a suitable level.•Drain water from the speaker.•Turn the internal speaker ON in set mode.	p. 10 p. 10 — p. 39
Transmitting is impossible, or high power cannot be selected.	<ul style="list-style-type: none">•Some channels are for low power or receive only.•The output power is set to low.	<ul style="list-style-type: none">•Change channels.•Push [H/L] to select high power.	pgs. 8, 46 p. 10
Scan does not start.	<ul style="list-style-type: none">•“TAG” channel is not programmed.	<ul style="list-style-type: none">•Set the desired channels as “TAG” channels.	p. 15
No beep sounds.	<ul style="list-style-type: none">•Beep tone is turned OFF.•The squelch is open.	<ul style="list-style-type: none">•Turn the beep tone ON in set mode.•Set squelch to the threshold point.	p. 38 p. 10
Distress call cannot be transmitted.	<ul style="list-style-type: none">•MMSI (DSC self ID) code is not programmed.	<ul style="list-style-type: none">•Program the MMSI (DSC self ID) code.	p. 16

11 CHANNEL LIST

• International channels

CH	Frequency (MHz)		CH	Frequency (MHz)		CH	Frequency (MHz)		CH	Frequency (MHz)		CH	Frequency (MHz)		CH	Frequency (MHz)	
	Transmit	Receive		Transmit	Receive		Transmit	Receive		Transmit	Receive		Transmit	Receive		Transmit	Receive
01	156.050	160.650	11	156.550	156.550	21	157.050	161.650	62	156.125	160.725	72	156.625	156.625	82	157.125	161.725
02	156.100	160.700	12	156.600	156.600	22	157.100	161.700	63	156.175	160.775	73	156.675	156.675	83	157.175	161.775
03	156.150	160.750	13	156.650	156.650	23	157.150	161.750	64	156.225	160.825	74	156.725	156.725	84	157.225	161.825
04	156.200	160.800	14	156.700	156.700	24	157.200	161.800	65	156.275	160.875	75 [†]	156.775	156.775	85	157.275	161.875
05	156.250	160.850	15 [†]	156.750	156.750	25	157.250	161.850	66	156.325	160.925	76 [†]	156.825	156.825	86	157.325	161.925
06	156.300	156.300	16	156.800	156.800	26	157.300	161.900	67	156.375	156.375	77	156.875	156.875	87	157.375	157.375
07	156.350	160.950	17 [†]	156.850	156.850	27	157.350	161.950	68	156.425	156.425	78	156.925	161.525	88	157.425	157.425
08	156.400	156.400	18	156.900	161.500	28	157.400	162.000	69	156.475	156.475	79	156.975	161.575			
09	156.450	156.450	19	156.950	161.550	60	156.025	160.625	70 [‡]	156.525	156.525	80	157.025	161.625			
10	156.500	156.500	20	157.000	161.600	61	156.075	160.675	71	156.575	156.575	81	157.075	161.675			

• USA channels (for U.K. version only)

CH	Frequency (MHz)		CH	Frequency (MHz)		CH	Frequency (MHz)		CH	Frequency (MHz)		CH	Frequency (MHz)		CH	Frequency (MHz)	
	Transmit	Receive		Transmit	Receive		Transmit	Receive		Transmit	Receive		Transmit	Receive		Transmit	Receive
01A	156.050	156.050	12	156.600	156.600	22A	157.100	157.100	64A	156.225	156.225	77 [†]	156.875	156.875	86	157.325	161.925
--	---	---	13 [†]	156.650	156.650	23A	157.150	157.150	65A	156.275	156.275	78A	156.925	156.925	86A	157.325	157.325
03A	156.150	156.150	14	156.700	156.700	24	157.200	161.800	66A	156.325	156.325	79A	156.975	156.975	87	157.375	161.975
--	---	---	15 [†]	156.750	156.750	25	157.250	161.850	67 [†]	156.375	156.375	80A	157.025	157.025	87A	157.375	157.375
05A	156.250	156.250	16	156.800	156.800	26	157.300	161.900	68	156.425	156.425	81A	157.075	157.075	88	157.425	162.025
06	156.300	156.300	17 [†]	156.850	156.850	27	157.350	161.950	69	156.475	156.475	82A	157.125	157.125	88A	157.425	157.425
07A	156.350	156.350	18A	156.900	156.900	28	157.400	162.000	70 [‡]	156.525	156.525	83A	157.175	157.175			
08	156.400	156.400	19A	156.950	156.950	37A	157.850	157.850	71	156.575	156.575	84	157.225	161.825			
09	156.450	156.450	20	157.000	161.600	61A	156.075	156.075	72	156.625	156.625	84A	157.225	157.225			
10	156.500	156.500	20A	157.000	157.000	--	---	---	73	156.675	156.675	85	157.275	161.875			
11	156.550	156.550	21A	157.050	157.050	63A	156.175	156.175	74	156.725	156.725	85A	157.275	157.275			

[†]Low power only.

[‡]Receive only.

■ Specifications

Specifications are measured in accordance with EN301 025

◇ General

- Frequency coverage :
 - Transmit 156.000–161.450 MHz
 - Receive 156.000–163.425 MHz
- Mode : FM (16K0G3E)
DSC (16K0G2B)
- Current drain (at 13.8 V) : TX high (25 W) 5.5 A
Max. audio 1.5 A
- Power supply requirement : 13.8 V DC ±15%
(negative ground)
- Frequency stability : ±0.8 kHz (–20°C to +60°C)
- Antenna connector : SO-239 (50 Ω)
- Input impedance (MIC) : 2 kΩ
- Output impedance (audio) : 4 Ω
- Dimensions (Proj. not included): 220(W) × 110(H) × 109.4(D) mm
- Weight : 1350 g

◇ Transmitter

- RF output power : 25 W and 1 W
- Modulation system : Variable reactance frequency modulation
- Max. frequency deviation : ±5.0 kHz
- Spurious emissions : Less than 0.25 μW
- Residual modulation : More than 40 dB
- Audio harmonic distortion : Less than 10%
(at 1 kHz, 60% deviation)

◇ Receiver

- Receive system : Double conversion superheterodyne
- Intermediate frequencies : 1st; 31.05 MHz, 2nd; 450 kHz
(CH 70 receiver) 1st; 21.70 MHz, 2nd; 450 kHz
- Sensitivity (20 dB SINAD) : –5 dBμ emf typical
(CH 70 receiver) –5 dBμ emf typical
- Squelch sensitivity : –5 dBμ emf typical
- Spurious response : More than 75 dB
- Intermodulation : More than 75 dB
- Adjacent channel selectivity : More than 75 dB
- Hum and noise : More than 45 dB
- Audio output power : 2 W

■ Options

• MB-75 FLUSH MOUNT (p. 43)

For mounting the transceiver to a panel.

• HM-134 REMOTE-CONTROL MICROPHONE (p. 50)

External microphone-type controller. Provides optional intercom operation. 6 m microphone cable and mounting base included.

• HM-137 SMART-SPEAKER-MICROPHONE (p. 7)

Same as supplied.

• OPC-999 MICROPHONE EXTENSION CABLE

6 m microphone extension cable for optional HM-134. Up to 2 OPC-999 can be connected. (18 m maximum)

All stated specifications are subject to change without notice or obligation.

■ Panel description

The optional HM-134 remotely controls the IC-M601 and provides an optional intercom function.

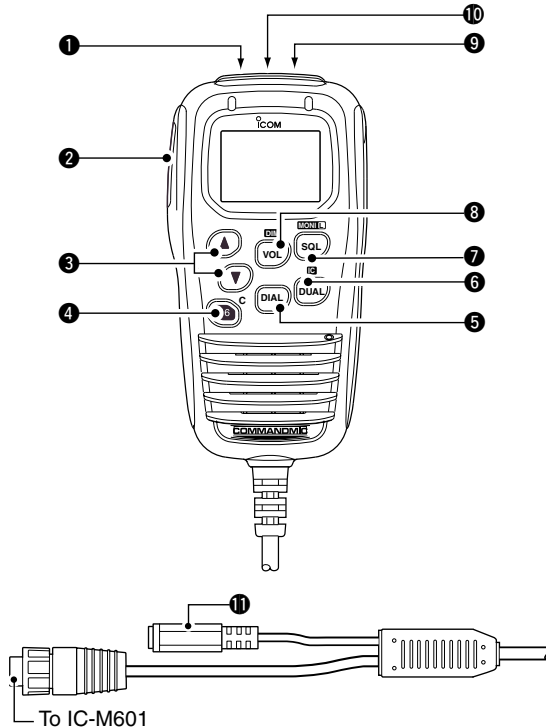

❶ POWER SWITCH [PWR] (pgs. 10, 53)

When the IC-M601 power is turned ON, push and hold for 2 sec. to turn the HM-134 power ON or OFF.

❷ PTT SWITCH [PTT] (pgs. 10, 53)

Push and hold to transmit; release to receive.

❸ CHANNEL UP/DOWN SWITCHES [▲]/[▼]

➤ Push either switch to change the operating channel, set mode contents, etc. (pgs. 10, 53)

➤ While pushing and holding [VOL], push [▲]/[▼] to adjust the brightness of the LCD and switch backlight. (p. 54)

➤ After [VOL] or [SQL] is pushed, push either switch to adjust audio level or noise squelch level, respectively. (pgs. 10, 53)

➤ In set mode, changes setting of the selected item. (pgs. 37, 57)

➤ During scanning, checks tag channels or changes scanning direction. (pgs. 15, 55)

❹ CHANNEL 16/CALL CHANNEL SWITCH [16•C]

➤ When pushed, selects Channel 16. (pgs. 8, 52)

➤ When pushed and held for 1 sec., selects call channel. (pgs. 8, 52)

• "CALL" appears when call channel is selected.

➤ When call channel is selected, push and hold for 3 sec. to enter call channel programming condition. (pgs. 11, 55)

➤ While pushing and holding [H/L], enters channel comment programming condition. (pgs. 11, 58)

- ➔ Enter set mode when pushed and held while turning power ON. (pgs. 37, 57)

5 DIAL SWITCH [DIAL]

- ➔ Selects and toggles the regular channels when pushed momentarily. (pgs. 9, 52)
- ➔ While pushing and holding [H/L], push to select channel group. (pgs. 9, 52)
 - International and U.S.A. channels are available for regular channels. (depends on transceiver's version)

6 DUAL-WATCH/INTERCOM SWITCH [DUAL•IC]

- ➔ Push to start dualwatch or tri-watch. (pgs. 13, 56)
- ➔ Push and hold for 1 sec. to activate the intercom function. (pgs. 36, 58)
- ➔ Push to stop dualwatch or tri-watch when either is activated.
- ➔ While pushing and holding the switch, you can call the IC-M601 in intercom mode. (pgs. 36, 58)

7 SQUELCH/MONITOR/LOCK SWITCH [SQL•MONI•L]

- ➔ After pushing [SQL], [▲]/[▼] sets the squelch threshold level. (p. 53)
- ➔ Push and hold [SQL•MONI•L] for 1 sec. to turn the monitor function ON. (p. 54)
- ➔ While pushing and holding [H/L], push [SQL•MONI•L] to toggle the microphone key lock function ON or OFF. (p. 54)
 - “” appears while key lock function is in use.
 - [PWR], [PTT], [VOL], [SQL] and [H/L] still function when the microphone key lock function is turned ON.

- ➔ Advances the cursor while in channel comment programming condition. (pgs. 11, 58)

8 VOLUME/DIMMER SWITCH [VOL•DIM]

- ➔ After pushing [VOL], [▲]/[▼] adjusts the audio level.
- ➔ Push and hold [VOL•DIM] for 1 sec. to adjust the brightness of the LCD and switch backlight. (p. 54)
- ➔ Moves the cursor backward while in channel comment programming condition. (pgs. 11, 58)

9 TRANSMIT POWER SWITCH [H/L]

- ➔ When pushed, toggles high and low power. (pgs. 10, 53)
 - Some channels are set to low power only.
- ➔ While pushing and holding this switch, other switches perform secondary functions.
- ➔ Toggles the all key lock function ON or OFF when pushed and held while turning power ON. (p. 54)
 - “” flashes while the all key lock function is in use.
 - Only [PWR] and [PTT] function when the all key lock function is in use.

10 SCAN SWITCH [SCAN•TAG] (pgs. 15, 57)

- ➔ Starts and stops normal or priority scan when tag channels are programmed.
- ➔ Push and hold [SCAN•TAG] for 1 sec. to set the displayed channel as a tag (scanned) channel.
- ➔ While pushing and holding [H/L], push and hold for 3 sec. to clear all tag channels.

13 HM-134 REMOTE-CONTROL MICROPHONE

⑪ EXTERNAL SPEAKER JACK

- Connect the external speaker (an 8 Ω load). The internal speaker can be deactivated via the Set mode programming. (p. 39)
- The speaker output employs a BTL (Balanced Trans-Less) circuit, **NEVER** connect the speaker cable to ground (or chassis). Use a floating setup.

CAUTION: After connecting the external speaker jack, cover the jack with water resistant tape as shown below to avoid water seeping into the microphone. Binding the mic-cable and external-speaker jack connection mold with water resistant tape increases the water-proofing of the connection mold.

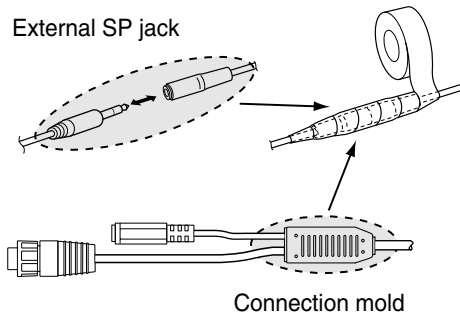

■ Function display

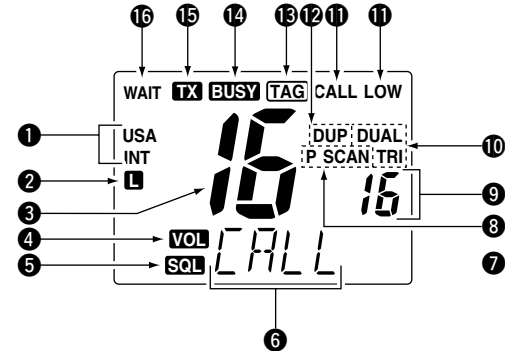

- ① CHANNEL GROUP INDICATOR** (pgs. 9, 52)
Indicates whether an International (INT) or U.S.A. (USA) channel is selected. (depends on transceiver's version)
- ② KEY LOCK INDICATOR** (p. 54)
 - Appears while the key lock function is in use.
 - Flashes while the all key lock function is in use.
- ③ CHANNEL NUMBER READOUT**
 - Indicates the selected operating channel number. "A" appears when a simplex channel is selected. (pgs. 9, 52)
 - In set mode, indicates the selected condition. (pgs. 37, 57)

- 4 VOLUME INDICATOR** (p. 53)
Appears while audio output level is adjusted.
- 5 SQUELCH INDICATOR** (p. 53)
Appears while noise squelch level is adjusted.
- 6 CHANNEL COMMENT INDICATOR**
➤ Channel comment appears (and scrolls) if programmed. (pgs. 11, 58)
➤ In set mode, indicates or scrolls the selected set mode item. (pgs. 37, 57)
- 7 SCAN INDICATOR** (pgs. 15, 55)
➤ “SCAN” appears during normal scan.
➤ “P SCAN” appears during priority scan.
- 8 PRIORITY CHANNEL INDICATOR**
➤ Indicates a priority channel during priority scan or dual/tri-watch. (pgs. 13, 56)
➤ “IC” appears during intercom mode. (pgs. 36, 58)
- 9 DUAL/TRI WATCH INDICATOR** (pgs. 13, 56)
“DUAL” appears during dualwatch; “TRI” during tri-watch.
- 10 LOW POWER INDICATOR** (pgs. 10, 53)
Appears when low power is selected.
- 11 CALL CHANNEL INDICATOR** (pgs. 8, 52)
Appears when the call channel is selected.
- 12 DUPLEX INDICATOR** (pgs. 9, 52)
Appears when a duplex channel is selected.
- 13 TAG CHANNEL INDICATOR** (pgs. 15, 56)
Appears when a tag channel is selected.
- 14 BUSY INDICATOR** (pgs. 10, 53, 54)
Appears when receiving a signal or when the squelch opens.
- 15 TRANSMIT INDICATOR** (pgs. 10, 53)
Appears while transmitting.
- 16 “WAIT” INDICATOR**
“WAIT” appears in the HM-134 display while transmitting via the IC-M601’s attached microphone.
• In the above case, the connected HM-134 does not have priority.

■ Channel selection

◇ Channel 16

- ① Push [16•C] to select Channel 16.
- ② Push [DIAL] to return to the condition before selecting Channel 16, or push [▲] or [▼] to select operating channel.
 - Output power turns to “25W” automatically, whenever Channel 16 is selected.



Push 

◇ Call channel

- ① Push and hold [16•C] for 1 sec. to select call channel.
- ② Push [DIAL] to return to the condition before selecting call channel, or push [▲] or [▼] to select operating channel.



Push  for 1 sec.

◇ U.S.A. and International channels

- ① Push [DIAL] to select regular channel.
- ② While pushing and holding [H/L], push [DIAL] to select channel group. (depends on transceiver's version)
 - U.S.A. or International can be selected in sequence.

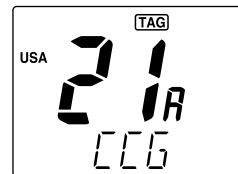

U.S.A. channels

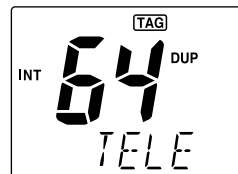
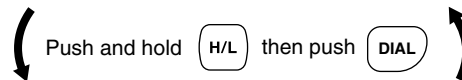

International channels

■ Receiving and transmitting

- ① Push [PWR] to turn power ON.
- ② Push [VOL], then [▲]/[▼] to adjust audio output level.
 - Push [SQL], then [▲]/[▼] to mute any audio noise, if necessary.
- ③ Push [▲]/[▼] to select the desired channel.
 - When receiving a signal, “**BUSY**” appears and audio is emitted from the speaker.
 - Further adjustment of audio level may be necessary at this point.
- ④ Push [H/L] to select the output power, if necessary.
 - “LOW” appears when low power is selected.
 - Choose low power to reduce an intermodulation for other stations, choose high power for longer distance communications.
 - Some channels are low power only.
- ⑤ Push and hold [PTT] to transmit, then speak into the microphone.
 - “**TX**” appears.
 - Channel 70 cannot be used for transmission.
- ⑥ Release [PTT] to receive.

/// **IMPORTANT:** To maximize the readability of your transmitted signal (voice), pause a few sec. after pushing [PTT], hold the microphone 2.5 to 5 cm from your mouth and speak at a normal voice level.

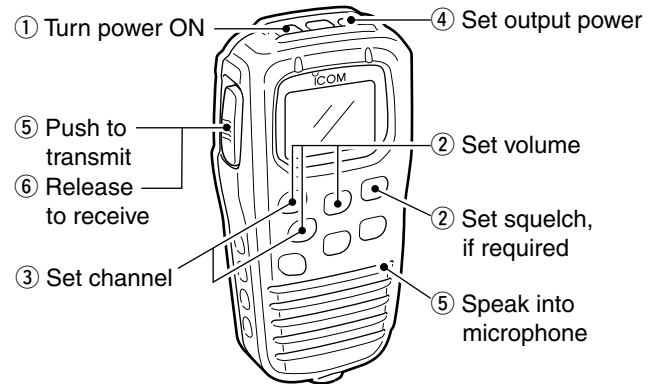

■ Lock functions

The lock function electronically locks keys and switches to prevent accidental changes and function access from the microphone.

- All keys, switches and controllers on the transceiver are functional.

◇ Activating the lock function

➔ While pushing and holding [H/L], push [SQL•MONI•L] to turn the lock function ON and OFF.

- “**L**” appears.
- Only [PWR], [PTT], [H/L], [SQL•MONI•L], [VOL]+[▲]/[▼] and [SQL]+[▲]/[▼] are functional.

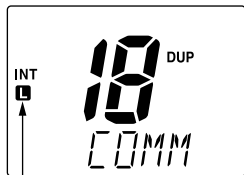

Appears when the lock function is in use.

◇ Activating the all key lock function

➔ While pushing and holding [H/L], turn the power ON by pushing [PWR] to turn the all key lock function ON and OFF.

- “**L**” flashes.
- Only [PWR] and [PTT] are functional.

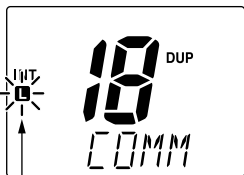

Flashes when the all lock function is in use.

■ Display backlighting

The function display and switches can be backlit for better visibility under low light conditions. And the backlighting condition can be adjusted independently from the transceiver.

- ① Push and hold [VOL•DIM] for 1 sec. to enter backlight adjusting mode.
 - “**DIM**” with number of backlight level appears in the channel comment indicator.
- ② Push [▲]/[▼] to adjust the backlight level.
 - The backlight level is adjustable between 0 (lights OFF) and 7 (brightest).

■ Monitor function

The monitor function releases the noise squelch mute of the microphone only. (An independent noise squelch system is employed.)

- ➔ Push and hold [SQL•MONI•L] for 1 sec. to activate the monitor function.
- “**BUSY**” flashes and audio is emitted.
 - Any key, except [▲]/[▼], cancels the monitor function.

■ Call channel programming

- ① While pushing and holding [H/L], push [DIAL] several times to select the desired channel group (USA or INT) to be programmed. (depends on transceiver's version)



- ② Push and hold [16•C] for 1 sec. to select the call channel of the selected channel group.
•“CALL” and call channel number appear.



- ③ Push and hold [16•C] again for 3 sec. (until long beep changes to 2 short beeps) to enter call channel programming condition.
•Call channel number and channel group to be programmed flashes.

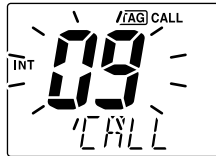

- ④ Push [▲]/[▼] to select the desired channel.

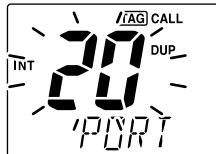

- ⑤ Push [16•C] to program the displayed channel as the call channel.
•The call channel number and channel group stop flashing.

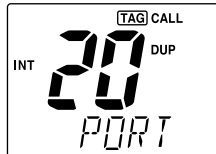

■ Starting a scan

- ① While pushing and holding [H/L], push [DIAL] once or twice to select the channel group (USA or INT), if desired.
- ② Push [SCAN•TAG] to start priority or normal scan.
- “SCAN” appears during normal scan.
 - The priority channel readout indicates “16”, and “P” and “SCAN” indicators appear during priority scan.
 - When a signal is received, scan pauses until the signal disappears or resumes after pausing 5 sec. according to set mode setting (Channel 16 is still monitored during priority scan).
 - Push [▲]/[▼] to check the scanning tag channels, to change the scanning direction or resume the scan manually.
- ③ To stop the scan, push [SCAN•TAG].
- “SCAN” disappears.
 - Pushing [PTT], [16•C] or [DIAL] also stops the scan.

■ Setting tag channels

- ① While pushing and holding [H/L], push [DIAL] once or twice to select the channel group (USA and INT), if desired. (depends on transceiver's version)
- ② Push [▲]/[▼] to select the desired channel to set as a tag channel.
- ③ Push and hold [SCAN•TAG] for 1 sec. to set the displayed channel as a tag channel.
 - “TAG” appears.
- ④ To cancel the tag channel setting, push and hold [SCAN•TAG] for 1 sec.
 - “TAG” disappears.

•Clearing all tag channels in the selected channel group

- ➡ While pushing and holding [H/L], push [SCAN•TAG] for 3 sec. to clearing all tag channels. (until long beep changes to 2 short beeps)

■ Dualwatch/Tri-watch operation

- ① Push [▲]/[▼] to select the desired channel.
 - While pushing and holding [H/L], push [DIAL] once or twice to select the channel group (USA, INT), if desired. (depends on transceiver's version)
- ② Push [DUAL] to start dualwatch or tri-watch.
 - “DUAL” appears during dualwatch; “TRI” appears during tri-watch.
 - Beep tone sounds when a signal is received on Channel 16.
 - Tri-watch becomes dualwatch when receiving a signal on the call channel.
- ③ To cancel dualwatch/tri-watch, push [DUAL•IC] again.

■ Set mode programming

Set mode is used to change the condition of the transceiver's functions and the microphone's own functions:

Transceiver's functions—

scan type (normal or priority), scan resume timer, dual-watch/tri-watch of COMMANDMIC, transceiver's beep tone, internal speaker (transceiver), LCD contrast (transceiver) and foghorn frequency.

Microphone's own functions—

beep tone function (microphone) and LCD contrast (microphone).

In this section, instructions are for the microphone's own functions only. Refer to pgs. 37–39 for the setting of the other functions. (Some functions may not be selectable from the microphone.)

◇ Entering set mode

- ① Turn power OFF.
- ② While pushing and holding [16•C], turn power ON.
 - After beep emission, a set mode item (in the channel comment indicator and condition in the channel number readout) is displayed.
- ③ Push [16•C] to select the desired item, if necessary.
- ④ Push [▲]/[▼] to select the desired condition of the item.
- ⑤ Turn power OFF, then ON to exit set mode.

• Beep tone “BEEP”

→ Push [▲] to turn ON, [▼] to turn OFF the beep output.

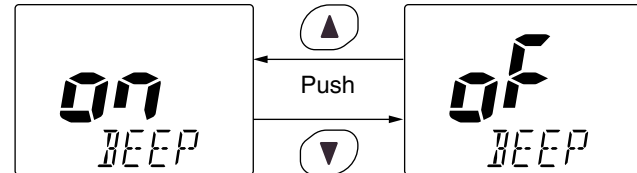

• LCD contrast “LCD CONTRAST”

→ Push [▲]/[▼] to adjust to a suitable LCD contrast.

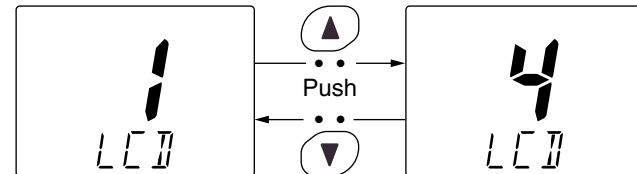

• Internal speaker “INT-SPEAKER”

→ Push [▲]/[▼] to turn the HM-134 internal-speaker ON/OFF.

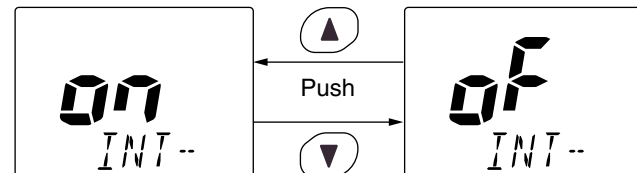

■ Intercom operation

- ① Push and hold [DUAL•IC] for 1 sec. to activate the intercom function.
 - "IC" appears in the channel readout.
 - The channel comment disappears.
- ② Push [PTT] to talk.
 - "TRK" appears in the channel comment indicator.
- ③ Release [PTT] to listen.
 - "LSTN" appears in the channel comment indicator when the transceiver is in talking mode.
- ④ Push [DUAL•IC] to cancel the intercom function.
 - Pushing [16] is also cancels the intercom function.

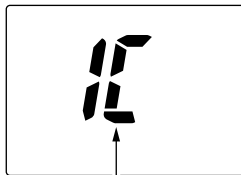

Appears when the intercom function is in use.

For your reference:

In case the intercom mode is selected with the transceiver during microphone power OFF, the microphone power is automatically turned ON and the intercom mode is selected.

◆ Intercom beep function

- ➡ Push and hold [DUAL•IC] for more than 1 sec.
 - Emits intercom beep while holding.

■ Channel comments

- ① Push [▲]/[▼] to select a channel to program the channel comment.
 - While pushing and holding [H/L], push [DIAL] several times to select the channel group (USA and INT), if desired.
- ② While pushing and holding [H/L], push [16•C].
 - The 1st character of the currently programmed comment flashes.
- ③ Push [▲]/[▼] to select a character.
- ④ Push [SQL] to move to right; then push [▲]/[▼] to select a character.
 - Push [VOL] to move to left.
- ⑤ Continue until the desired characters have been selected, then push [16•C] to return to normal operation condition.

• Available characters

(space)	! (!)	" (")	# (#)	\$ (\$)	% (%)	& (&)	' (')	((() ()
* (*)	+ (+)	, (,)	-- (-)	, (,)	/ (/)	0 (0)	1 (1)	2 (2)	3 (3)
4 (4)	5 (5)	6 (6)	7 (7)	8 (8)	9 (9)	A (A)	B (B)	C (C)	D (D)
E (E)	F (F)	G (G)	H (H)	I (I)	J (J)	K (K)	L (L)	M (M)	N (N)
O (O)	P (P)	Q (Q)	R (R)	S (S)	T (T)	U (U)	V (V)	W (W)	X (X)
Y (Y)	Z (Z)	a (a)	b (b)	c (c)	d (d)	e (e)	f (f)	g (g)	h (h)
i (i)	j (j)	k (k)	l (l)	m (m)	n (n)	o (o)	p (p)	q (q)	r (r)
s (s)	t (t)	u (u)	v (v)	w (w)	x (x)	y (y)	z (z)		

■ HM-134 supplied accessories

Accessories included with the HM-134:	Qty.
① Connection cable (OPC-1000: 6 m)	1
② Mounting base	1
③ Microphone hanger	1
④ Screws (M3 × 16; tapping)	5

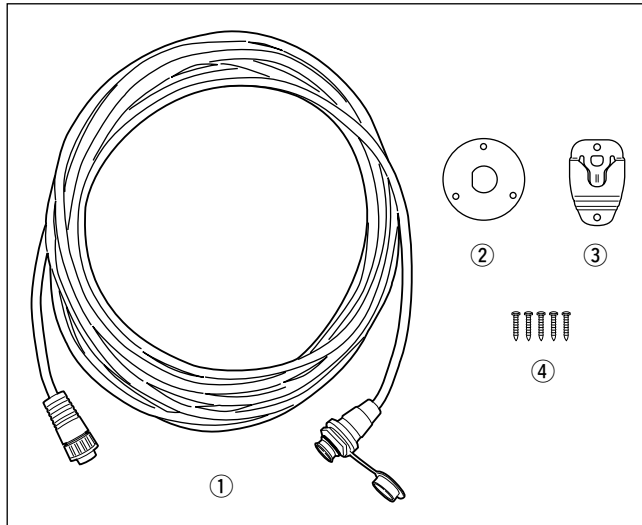

■ Installation

The optional HM-134 can be connected to the transceiver directly, as well as via the supplied connection cable for longer distance remote operation. The connector of the connection cable can be installed into a cabinet, wall, etc., as a built-in plug.

For longer distance remote operation, the optional extension cable, OPC-999 (6 m; Connecting between transceiver and the connection cable), is available, and up to 2 OPC-999 can be added.

- ① Insert the supplied cable into the external microphone jack and tighten the cable nut as shown below.

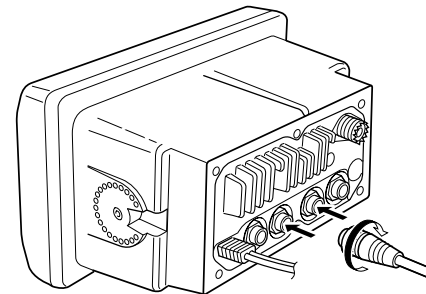

14 HM-134 CONNECTIONS AND INSTALLATION

- ② To use the supplied cable as a wall socket, follow the below steps.
- ③ Using the mounting base, carefully mark off the 2 spots where the cable and screws will be fastened.
- ④ Drill holes at these marks.
- ⑤ Install the mounting base using the supplied screws as shown below.

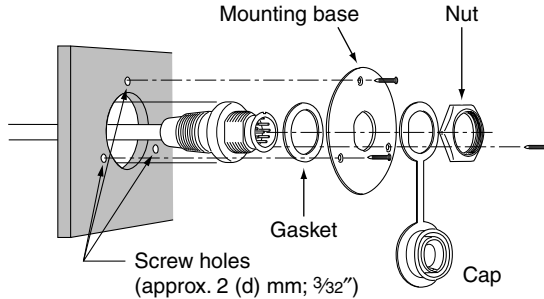

- ⑥ The completed installation should look like this.

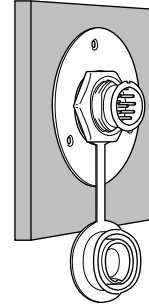

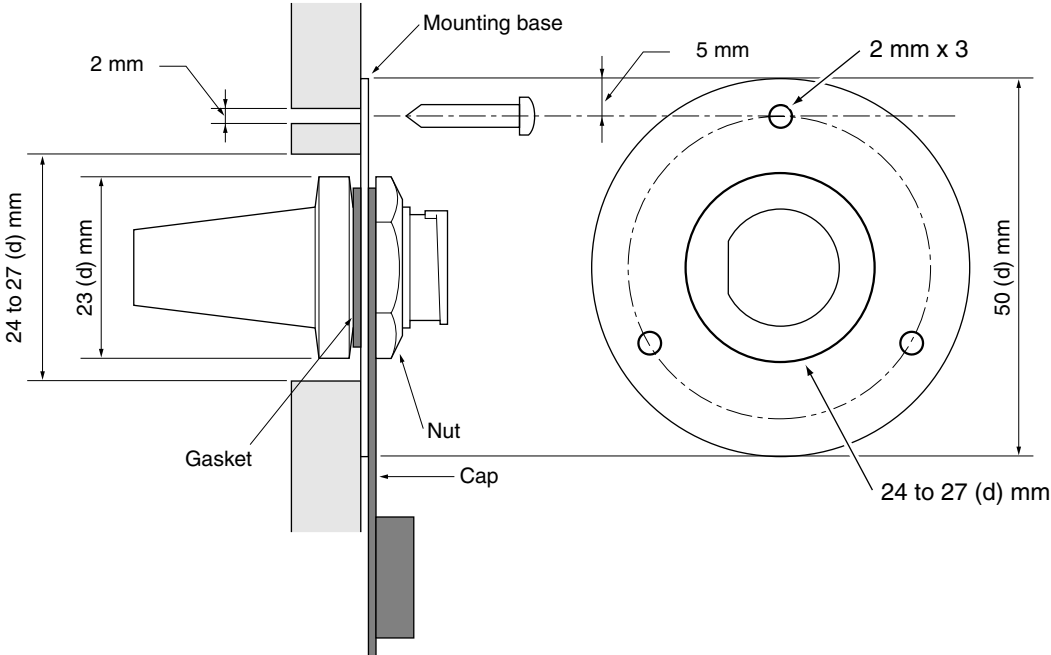

■ Installation notes

The installation of this equipment should be made in such a manner as to respect the EC recommended electromagnetic field exposure limits (1999/519/EC).

The maximum RF power available from this device is 25 watts. The antenna should be installed as high as possible for maximum efficiency and that this installation height should be at least 5 meters above ground (or accessible) level. In the case where an antenna cannot be installed at a reasonable height, then the transmitter should neither be continuously operated for long periods if any person is within 5 meters of the antenna, nor operated at all if any person is touching the antenna.

In all cases any possible risk depends on the transmitter being activated for long periods. (actual recommendation limits are specified as an average of 6 minutes) Normally the transmitter is not active for long periods of time. Some radio licenses will require that a timer circuit automatically cuts the transmitter after 1–2 minutes etc.

Similarly some types of transmitter, SSB, CW, AM, etc. have a lower 'average' output power and the perceived risk is even lower.

HM-134 TEMPLATE

HM-134 TEMPLATE

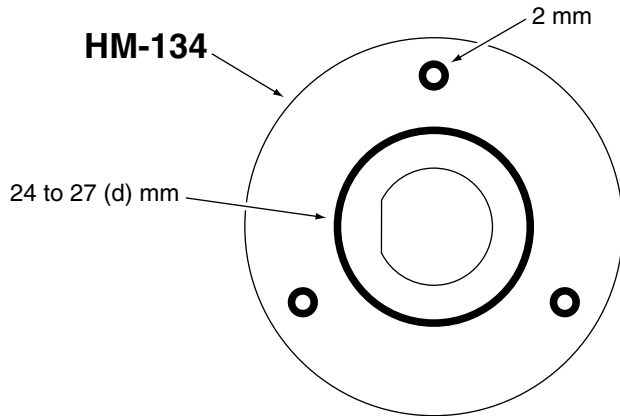

Cut here



DECLARATION OF CONFORMITY

We Icom Inc. Japan
1-1-32, Kamiminami, Hirano-ku
Osaka 547-0003, Japan

Declare on our sole responsibility that this equipment complies with the essential requirements of the Radio and Telecommunications Terminal Equipment Directive, 1999/5/EC, and that any applicable Essential Test Suite measurements have been performed.

Kind of equipment: VHF MARINE TRANSCEIVER

Type-designation: IC-M601

Version (where applicable):

This compliances is based on conformity with the following harmonised standards, specifications or documents:

i)	<u>EN 301 025-2</u>	<u>V1.1.1 (2000-08)</u>
ii)	<u>EN 301 025-3</u>	<u>V1.1.1 (2001-05)</u>
iii)	<u>EN 60945</u>	<u>1997</u>
iv)	<u>EN 60950</u>	<u>August 1992, A11 1997</u>
v)	<u>EN 300 698-2</u>	<u>V1.1.1 (2000-08)</u>
vi)	<u>EN 300 698-3</u>	<u>V1.1.1 (2001-05)</u>

C **€0560** **!**

Düsseldorf 25th Oct. 2002
Place and date of issue

Icom (Europe) GmbH
Himmelgeisterstraße 100
D-40225 Düsseldorf

Authorized representative name

T. Maebayashi
General Manager

Signature

Icom Inc.

Count on us!

< Intended Country of Use >

- | | | | |
|------------------------------|------------------------------|------------------------------|------------------------------|
| <input type="checkbox"/> GER | <input type="checkbox"/> FRA | <input type="checkbox"/> ESP | <input type="checkbox"/> SWE |
| <input type="checkbox"/> AUT | <input type="checkbox"/> NED | <input type="checkbox"/> POR | <input type="checkbox"/> DEN |
| <input type="checkbox"/> GBR | <input type="checkbox"/> BEL | <input type="checkbox"/> ITA | <input type="checkbox"/> FIN |
| <input type="checkbox"/> IRL | <input type="checkbox"/> LUX | <input type="checkbox"/> GRE | <input type="checkbox"/> SUI |